



**HILTI**

# SAVING LIVES & ASSETS WITH INNOVATION AND EDUCATION

**Hilti Firestop Systems  
Application Guide**



# HILTI. AROUND THE WORLD SUPPORT.



**The Hilti Group is a world leader in developing, manufacturing and marketing added-value, top-quality products for professional customers in the construction industry and in building maintenance.**

Our product range covers drilling and demolition, direct fastening, diamond and anchoring systems, firestop and foam systems, installation, measuring and screw fastening systems as well as cutting and sanding systems. We are committed to excellence in innovation, total quality, direct customer relationships and effective marketing.

**Hilti operates in over 120 countries around the world.**

Of our more than 20,000 employees, two-third work directly for our customers, in sales organizations, engineering and customer service. We have production plants and research and development centers in Europe and Asia. Our corporate headquarters is located at Schaan in the Principality of Liechtenstein.

Founded in 1941, the worldwide Hilti Group evolved from a small family company. The Martin Hilti Family Trust holds all of the registered shares and, after going private in 2003, about 99 percent of the non-voting participation certificates of Hilti Corporation. The intention of the Martin Hilti Family Trust is to safeguard our founder Martin Hilti's life's work in the long term.

**Hilti's corporate policy aims to build stakeholder value.**

Only by integrating the interests of all the company's partners, at home and abroad – employees, customers, suppliers, local communities and authorities as well as the financial community – can we create the foundation of confidence on which Hilti builds its long-term success. Only by integrating the interests of all the company's partners, at home and abroad – employees, customers, suppliers, local communities and authorities as well as the financial community – can we create the foundation of confidence on which Hilti builds its long-term success.

## HILTI SYSTEMS & SOLUTIONS

Application	Planning & Specifying	Measuring	Drilling & Demolition	Cutting & Grinding	Fastening & Installation	Insulation & Protection	Professional & Services
	Specification Consulting Engineering Software	Distance Measuring Leveling & Aligning Sensing	Drilling & Chiseling Diamond Systems	Cutting Sanding Diamond Systems	Direct Fastening Screw Fastening Anchoring Installation	Foam Systems Fire Stopping	Repair Service Lifetime Service

We are committed to excellence in innovation, total quality, direct customer relationships and effective marketing.



## General Information

Introduction to Hilti	Page 1
Dedicated to life safety	Page 3
Website link and services	Page 4
The designer's problem and the Hilti solution	Page 5 - 6
Hilti Firestop system review	Page 9 - 11
Additional attributes	Page 12
Common trade applications	Page 13 - 14
Additional approvals & testing	Page 15 - 16



## Joint Sealants

CFS-S SIL/CP601S elastic firestop sealant	Page 17 - 18
CFS-S ACR/CP606 fire resistant joint filler	Page 19 - 20



## Joint Spray

CFS-SPWB/CP672 firestop joint spray	Page 21 - 22
-------------------------------------	--------------



## Intumescent

FS One Max high performance intumescent sealant	Page 23 - 24
CFS-F SOL/CP620 firestop foam	Page 25 - 26
CFS-F FX/CP660 expanding fire seal	Page 27 - 28



## Mortars

CFS-M RG/CP636 firestop mortar	Page 29 - 30
CP637 firestop mortar	Page 31 - 32
CP638 HS FS firestop mortar	Page 33 - 34



## Pipe Collars

CFS-C-EL Firestop Endless Collar	Page 35 - 38
CFS-C/CP643N intumescent firestop collar	Page 39 - 40
CFS-C P/CP644 intumescent firestop collar	Page 41 - 42
CFS-CID/CP680 cast in firestop device	Page 43 - 44



## Pipe Wraps

CFS-W SG/CP648-S intumescent firestop single wrap	Page 45 - 46
CFS-W EL/CP648-E intumescent firestop endless wrap	Page 47 - 48



## Reusables

CFS-PL intumescent firestop plug	Page 49 - 50
CFS-BL intumescent firestop brick	Page 51 - 52
CFS-CU/CP651N intumescent firestop cushion	Page 53 - 54
CFS-P PA/CP617 Firestop putty pad	Page 55 - 56



## Coated Board

CP670 firestop ablative coated board system	Page 57 - 58
---	--------------



## Cable Coatings

CFP-CI/CP 678 firestop cable coating	Page 59 - 60
CFP-CE/CP 679A ablative firestop cable coating	Page 61 - 62



## PU Foam

CF125-50 fire rated backing foam	Page 63 - 64
----------------------------------	--------------

## HILTI IS DEDICATED TO SAVING LIVES THROUGH INNOVATION AND EDUCATION

The quality and excellence of Hilti Firestop products help ensure that fire, smoke and toxic gases are contained to reduce the tragic loss of human life and property. Through a combination of superior products, advanced knowledge and unparalleled customer service we are able to provide the highest quality firestop systems in the world.



## HILTI OFFERS A COMPREHENSIVE SUPPORT PACKAGE

Throughout the entire Firestopping process, whether it is specification, installation or inspection, Hilti will be there to offer job site support and expertise, Hilti's highly trained Sales Force, Fire Protection Specialists and in-house Fire Protection Engineering team can help you select the correct products and systems to match your specific project needs. Hilti has a support package that is unmatched in the passive firestop industry.

### Fire safety

Fire safety is a major concern for all who are responsible for the design and specification of new buildings. The causes of fire are varied and unpredictable, and often outside the control of the designer. What can be controlled, however, is the effect of fire once it has started. The control of fire within a building is normally affected by a combination of active and passive fire protection systems.

### Active fire protection systems

Active fire protection systems are designed to detect fire, and either to extinguish it by means of water sprinklers, halogen installations or fire extinguishers, or to minimize its effects by smoke ventilation. Active systems are also used to assist the escape of occupants by the provision of alarms or emergency lighting.

### Passive fire protection systems

Passive fire protection is designed into the structure of the building, so that if fire breaks out, it is contained within a fire compartment, surrounded by fire-resistive walls and floors. For the walls and floors to maintain their fire resistance, however, every opening, penetration and joint must be sealed against the escape of fire and smoke.

### Intumescent fire seals

The materials used to form the seals must not only fill all gaps at the time of construction, but also, in the event of fire, expand to close any further gaps formed by melted components. These intumescent fire seals, if properly installed, can help prevent fire escaping from a compartment for a rating period of up to four hours. This time period can prove vital in allowing occupants to escape, and fire fighters to control the fire.

### Hilti

Around the world the red Hilti toolbox is a familiar sight on building sites, and the Hilti name is known and respected. To most people Hilti means precision tools and secure fixings. For many years however, Hilti has applied their skills to a new area of construction where precision and security are vital: firestopping.

### Hilti firestop systems

The aim of Hilti firestop systems is to provide designers and specifiers with the following:

- excellent-finished solutions that match the well known, high quality standards associated with the Hilti product.
- easy installation-all firestop components are readily available and simple and fast to install.
- tested and used world wide-Hilti offers one-stop firestopping systems tested in accordance with most relevant regulations.
- wide ranging solutions-for virtually any opening or penetration through which heat or smoke might pass. Hilti offers a firestop solution that will help minimize damage in the event of a fire.

### Hilti and the designer/specifier

To assist the designer or specifier in selecting and specifying the appropriate firestop system, Hilti developed the online Firestop Design Center. Visit [www.hilti.co.uk](http://www.hilti.co.uk) or [www.us.hilti.com](http://www.us.hilti.com) and click on the link to the Firestop Design center to access specification tools and resources by application or by product name.

Hilti customized solutions If none of the standard firestop systems meet the requirements of the design, Hilti is ready to offer their expertise and work with the designer to produce customized solutions.

# WEBSITE LINK AND SERVICES



## **Firestop design centres in Hilti websites (Hilti Canada, France, GB, Germany, USA)**

State of the art tool designed to make specifications of Firestop even easier. Designed with you in mind, Hilti Firestop Specifier Design Centers easily solve application problems and let you download latest CAD drawings of Hilti firestop applications. Visit [www.hilti.co.uk](http://www.hilti.co.uk) / [www.us.hilti.com](http://www.us.hilti.com)

## **Project References**

Hilti firestop systems are used continuously worldwide in various types of projects. Please contact your local firestop specialist or Hilti center for international or local project references.

## **Engineering Judgement**

Hilti has performed extensive testing in both through- penetration and construction joint applications. However, due to variations in construction throughout the phases of a project, it is not possible to test every application that may be encountered. For these situations, Hilti has developed a process for creating custom drawings to accommodate particular applications. Hilti custom drawings, or Engineering Judgements, are developed through the careful and restricted application of accepted engineering principles and fire protection guidelines set forth by the IFC (International Firestop Council). Please contact your local Hilti firestop specialist if you require an Engineering Judgement solution.

## **Sample Written Specifications**

Sample written specifications for firestop are available in accordance to various international standards. It includes all required specification details on firestop expertly laid out for specifiers and designers. Please contact your local Hilti Firestop specialist for a copy of firestop sample specifications according to BS standard, ASTM standard, or to any other international standards.

## **MSDS**

Material Safety Data Sheets for all Hilti firestop systems are available if required. Please contact your local Hilti representative for details.

## **Test reports and approvals**

Test reports and approvals according to UL1479, UL2079, ULC, cUL, BS 476, DIN 4102, or any other international standard, or local approvals, are available upon request. Please contact your local Hilti Firestop specialist for further details.

## **Firestop Videos**

Videos are available for all Hilti firestop systems if required. Installation details of these systems are expertly explained in these videos.

## **Register now**

Open new doors within Hilti by registering online. Registered users have access to our comprehensive library, design center and free technical downloads. You can also opt in for our e-mail newsletters about the latest products.

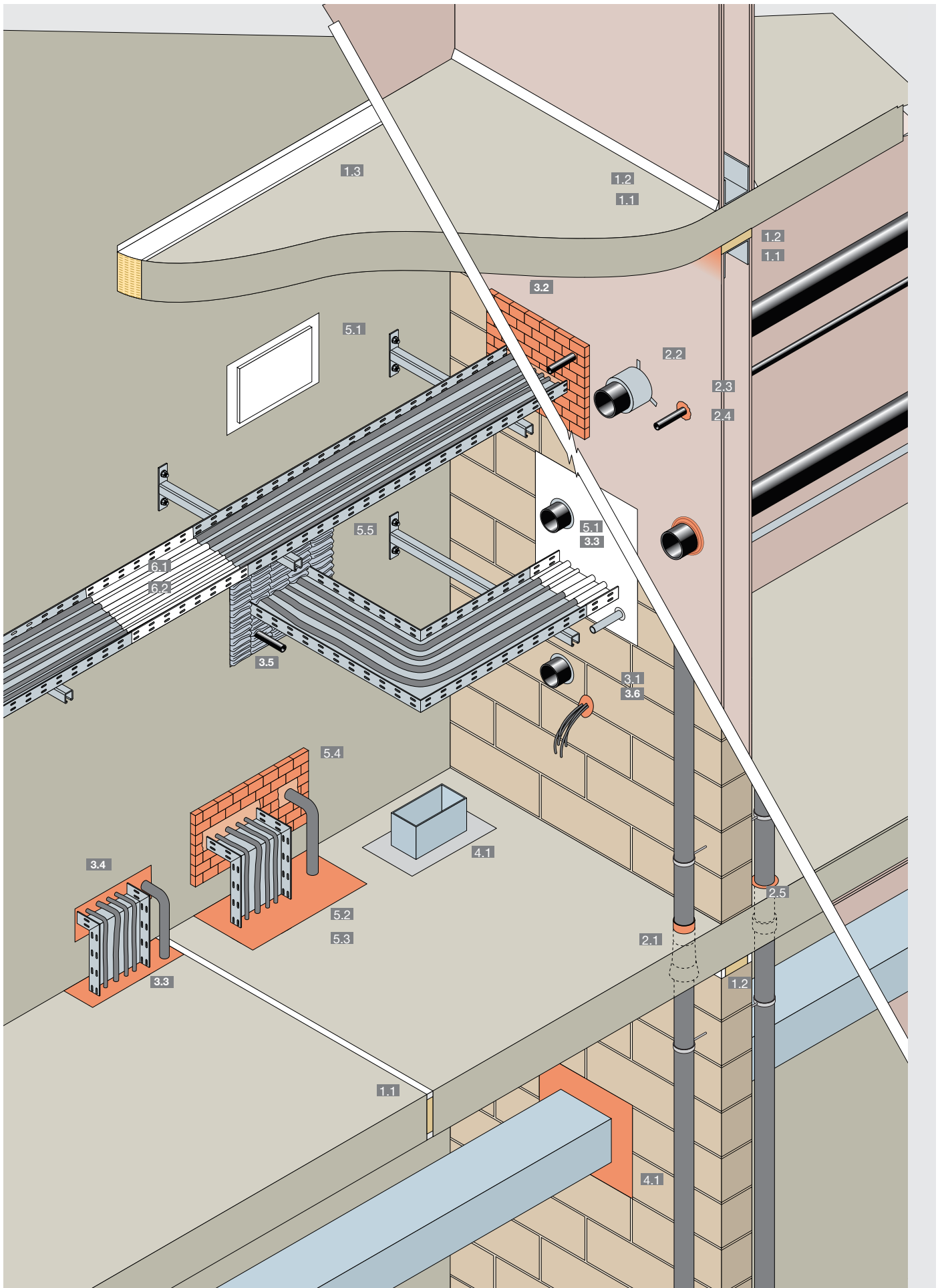

Divider	Hilti product	Description	Application	Fire rating
Joints	1.1 CP 601S/CFS-S SIL	Elastic Firestop Sealant	Movement joints	up to 4 hours
	1.2 CP 606/CF-S ACR	Fire Resistant Joint filler	Rigid or low movement joints	up to 4 hours
	1.3 CFS-SP-WB	Firestop Joint Spray	Curtain wall joints/performance joints	up to 4 hours
Pipes	2.1 CP 680/CFS-CID	Firestop Cast-in Device	Plastic and metal pipes with diameters up to 160 mm	up to 3 hours
	2.2 CP 644/CFS-C P	Firestop Collars	Plastic pipes with diameters up to 250 mm	up to 4 hours
	2.2 CP 643 N/CFS-C	Firestop Collars	Plastic pipes with diameters up to 160 mm	up to 3 hours
	2.3 CP 601S/CFS-S SIL	Elastic Firestop Sealant	Metal pipes	up to 2 hours
	2.4 CP 620/CFS-F SOL	Firestop Foam	Metal pipes (also for restricted access applications)	up to 2 hours
	2.4 CP 648/CFS-W	Firestop Wrap Strip	Plastic pipes with diameters up to 160 mm	up to 4 hours
Cable and cable trays	3.1 CFS-PL	Firestop Plug	Flexible sealing of single or bunched cable penetrations	up to 3 hours
	3.2 CFS-BL	Firestop Brick	Flexible sealing of cables and cable trays	up to 4 hours
	3.3 CP 670	FS Coated Board System	Permanent sealing of cables and cable trays	up to 2 hours
	3.4 CP 636/CFS-M RG	Firestop Mortar	Permanent sealing of cables and cable trays	up to 4 hours
	3.5 CP 651N/CFS-CU	Firestop Cushion	Flexible sealing of cables and cable trays	up to 2 hours
	3.6 CP 620/CFS-F SOL	Firestop Foam	Sealing of metal pipes and cables in restricted access applications	up to 2 hours
HVAC	4.1 CP 636/CFS-M RG	Firestop Mortar	Sealing around metal ductwork with fire damper	up to 4 hours
	4.1 CP 637	Firestop Mortar	High strength seal for metal ductwork with fire damper	up to 4 hours
	4.1 CP 638 HS FS	Firestop Mortar	High strength seal for metal ductwork with fire damper	up to 4 hours
Multiple/blank	5.1 CP 670	FS Coated Board System	Permanent sealing of metal and plastic pipes, cables and cable trays, in conjunction with other products, and sealing of blank openings	up to 2 hours
	5.2 CP 636/CFS-M RG	Firestop Mortar	Permanent sealing of metal and plastic pipes, cables and cable trays, in conjunction with other products – walls	up to 2 hours
	5.2 CP 637	Firestop Mortar	Permanent sealing of metal and plastic pipes, cables and cable trays, in conjunction with other products – walls and floors	up to 3 hours
	5.2 CP 638 HS FS	Firestop Mortar	Permanent sealing of metal and plastic pipes, cables and cable trays, in conjunction with other products – walls and floors	up to 3 hours
	5.3 CP 620/CFS-F SOL	Firestop Foam	Permanent sealing of metal pipes, cables and cable trays, in conjunction with other products	up to 2 hours
	5.4 CFS-BL	Firestop Brick	Flexible sealing of metal and plastic pipes, cables and cable trays, in conjunction with other products	up to 4 hours
	5.5 CP 651N/CFS-CU	Firestop Cushion	Flexible sealing of metal and plastic pipes, cables and cable trays, in conjunction with other products	up to 4 hours
Cable Coatings	6.1 CP 678/CFP-C I	Intumescent Cable Coating	Intumescent fire retardant coating	
	6.2 CP 679A/CFP-C E	Ablative Firestop Cable Coating	Ablative fire retardant coating	

# HILTI FIRESTOP PRODUCTS:

Developed, Tested And Trusted For  
Over 20 Years.



## HIGH-QUALITY AND SIMPLE-TO-USE FIRESTOP SYSTEMS



### Longtime experience

Hilti has been a leading manufacturer and supplier of high-quality and simple-to-use firestop systems for more than 20 years. The firestop portfolio can significantly increase the integrity of components and joints against fire / smoke in either new or existing structures.

- wide product portfolio for versatile applications
- products and solutions for facility owners, installers and inspectors, all approved by third parties
- firestop products that are approved for usage worldwide and have been extensively tested for fire resistance and smoketightness.



### Cable transit system

The Hilti cable transit system solves three problems simultaneously: fire-resistance, gas and watertightness.

- low inventory requirements – only seven different modules are needed to cover all cable diameters from 3 to 99 mm
- versatile adapter modules for quick, easy accommodation of each cable diameter
- significant savings thanks to module interlinking, especially where cables run vertically
- easy inspection – correct installation can be simply checked by the color-coded adapter system



### Firestop block

Installing cable penetrations with the Hilti firestop block is ideal for downstream applications as more cables are often added at a later stage. The Hilti firestop block is tested and approved for use with the Hilti firestop foam, simplifying the installation of additional cables.

- fast and simple installation process
- easy to install additional cables
- clean and tidy installation for large openings



### CFS-F SOL/CP 620 firestop foam

Hilti firestop foam is an ideal solution for installing reliable, smoke-resistant firestop seals in small-to-medium-sized openings. Perfect for electrical installation work.

- quick and easy installation
- trouble-free dispensing
- excellent sound insulation properties





## FIRESTOP SOLUTIONS FOR YOU

Find out what's inside: [www.hilti.co.za](http://www.hilti.co.za)

### CFS-BL firestop block

A flexible expanding firestop block of a polyurethane basis – a perfect solution especially when installation of additional cables is required at a later point in time.



### Hilti FS ONE MAX

The best intumescent firestop sealant, FS-ONE, just got better. With an extended shelf life, improved handling and an ethylene glycol-free composition, the next generation, high performing Hilti intumescent firestop sealant is here.



### CFS-S ACR/CP606 firestop acrylic sealant

Offers movement capabilities and excellent acoustic rating in fire rated joints. Also seals through penetration applications.



### CFS-C-EL Firestop Endless Collar

The Hilti CFS-C EL Firestop collar endless is a versatile solution for firestopping a wide range of plastic pipes passing through various types of fire rated base materials.



### CFS-S SIL/CP 601S firestop silicon sealant

Provides maximum movement capability in fire-rated joint applications and pipe penetrations.





### CFS-PL firestop plug

Ready-to-use intumescent flexible plugs, designed to firestop circular openings in fire-rated openings.

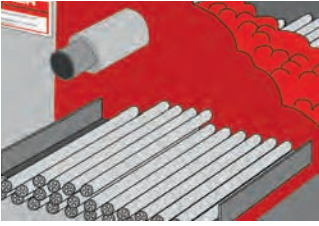
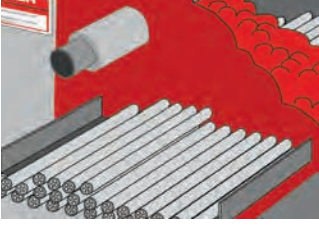
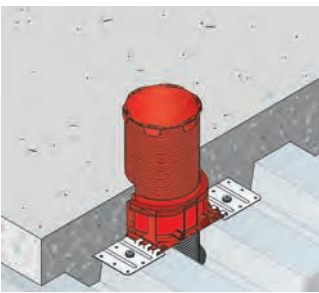
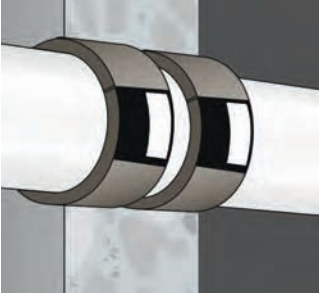
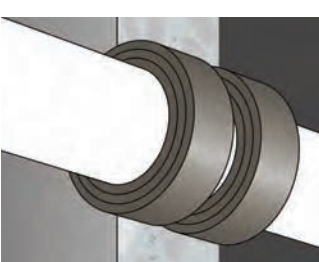
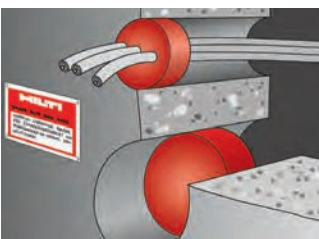
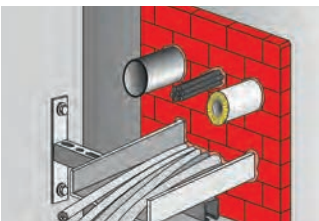

Picture	Product	Description	Application	Benefits	Tested and approved according to
	<b>1.1</b> CFS-S SIL/ CP 601S Elastic firestop sealant	Elastomeric firestop sealant (neutral silicone) that provides maximum movement in fire rated applications	<ul style="list-style-type: none"> <li>expansion joints and connection joints</li> <li>metal pipes up to 200 mm (UL std).</li> </ul>	<ul style="list-style-type: none"> <li>excellent movement capability</li> <li>fast and easy dispensing</li> <li>cost effective solutions</li> <li>smoke, gas and water tight</li> <li>good adhesion without use of a primer</li> <li>age tested for 30 years</li> <li>acoustically tested</li> <li>fire rating up to 4 hours</li> </ul>	BS, UL, AS DIN, FM, EN
	<b>1.2</b> CFS-S ACR/ CP 606 Fire resistant joint filler	An acrylic based firestop sealant for low movement in fire rated joints and small metal pipe joint applications	<ul style="list-style-type: none"> <li>rigid or low movement joints</li> <li>metal pipes</li> </ul>	<ul style="list-style-type: none"> <li>paintable</li> <li>fast and easy dispensing</li> <li>smoke, gas and water resistant</li> <li>excellent acoustic insulation</li> <li>fast and easy clean up with water</li> <li>age tested for 30 years</li> </ul>	BS, UL, AS, DIN, FM, EN
	<b>1.3</b> CFS-SP-WB Firestop joint spray	A sprayable fire-rated mastic for construction joints where maximum movement is required.	<ul style="list-style-type: none"> <li>top of wall joints</li> <li>curtain wall/ edge of slab</li> <li>expansion joints</li> </ul>	<ul style="list-style-type: none"> <li>maximum movement capability</li> <li>can be used with many standard sprayers</li> <li>water based formulation</li> <li>fast and easy clean up with water</li> <li>resists cracking after installation</li> <li>age tested up to 30 years</li> <li>tested by recognized cladding testing facilities</li> </ul>	UL, FM, BS, OPL, EN, DIN
	<b>2,3,5,9</b> FS-ONE MAX High performance intumescent firestop sealant	Intumescent fire protection for penetrations giving up to 4 hours protection	<ul style="list-style-type: none"> <li>plastic pipes up to 3" without additional collar</li> <li>single cable and cable bunches</li> <li>HVAC penetrations</li> <li>metal pipes</li> <li>insulated metal pipes</li> </ul>	<ul style="list-style-type: none"> <li>one product for most applications</li> <li>cost effective solutions</li> <li>fast and easy installation</li> <li>can be repenetrated when laying new cables</li> <li>paintable</li> <li>expansion several times original volume when exposed to heat sealing gaps of melted components</li> </ul>	UL, FM
	<b>3.9, 4.1, 5.2</b> CFS-M RG/ CP 636 Firestop mortar	Fire-resistant, cement-based mortar with thermal insulating properties for firestopping a wide variety of applications	<ul style="list-style-type: none"> <li>large multiple penetrations</li> <li>single cable, cable bunches and cable trays</li> <li>HVAC penetrations</li> <li>metal pipes</li> </ul>	<ul style="list-style-type: none"> <li>simple applications by trowel</li> <li>the mortar can be mixed to a stiff consistency, but form work may be required for large penetrations</li> <li>paintable</li> <li>Age tested upto 30 years</li> </ul>	BS, FM, DIN, AS, UL, EN
	<b>4.1, 5.2</b> CP 637 Structural Firestop mortar	A fast curing gypsum-based mortar for firestopping a wide variety of applications	<ul style="list-style-type: none"> <li>large multiple penetrations</li> <li>single cable, cable bunches and cable trays</li> <li>HVAC penetrations with dampers</li> </ul>	<ul style="list-style-type: none"> <li>easy to form and apply</li> <li>can be pumped, poured or trowelled</li> <li>paintable</li> <li>quick setting and remove forms within 2 hours</li> <li>suitable for light foot traffic (CP 637)</li> </ul>	BS, UL
	<b>2.2</b> CFS-C/ CP 643N Firestop collar	Ready-to-use quickly installed, galvanized sheet steel jacket containing sections of intumescent material	<ul style="list-style-type: none"> <li>plastic pipes with diameters from 1" (32 mm) up to 6" (160mm)</li> </ul>	<ul style="list-style-type: none"> <li>ready-to-use</li> <li>latch mechanism for quick and easy closure without use of a tool</li> <li>flexible tab positioning for convenient fastening</li> <li>allows for correct installation in tight areas</li> <li>good acoustic insulation</li> <li>age tested up to 30 years</li> </ul>	BS, UL, AS DIN, FM, EN

Picture	Product	Description	Application	Benefits	Tested and approved according to
	<b>2.2</b> CFS-C-EL Firestop Endless Collar	Ready to use, quick installation	<ul style="list-style-type: none"> <li>plastic pipes with diameters from 1" (25mm) to 6" (160 mm)</li> </ul>	<ul style="list-style-type: none"> <li>One product for multiple applications</li> <li>Endless solution: one product for all applications</li> <li>Problem solver for non-standard applications</li> <li>Easy installation</li> <li>Flexible solution for complex pipe configurations</li> </ul>	EN, DIN, EN ISO
	<b>2.2</b> CFS-C P/ CP 644 Firestop collar	Ready-to-use, quickly installed, with snap connection, steel jacket containing sections of intumescent material	<ul style="list-style-type: none"> <li>plastic pipes from 1.5" (50 mm) up to 10" (250 mm)</li> </ul>	<ul style="list-style-type: none"> <li>wide range of approvals</li> <li>ready-to-use</li> <li>snap connection for quick and easy closure without use of a tool</li> <li>flexible tab positioning for convenient fastening</li> <li>good acoustic insulation</li> <li>age tested up to 30 years</li> </ul>	BS, UL, AS DIN, EN
	<b>2.1</b> CFS-CID/ CP 680 Cast-in Firestop device	One step firestopping of pipes for protection up to 3 hours	<ul style="list-style-type: none"> <li>metal and plastic pipes from 1" (32 mm) up to 6" (170 mm)</li> </ul>	<ul style="list-style-type: none"> <li>one step installation</li> <li>no additional caulking</li> <li>ready-to-use</li> <li>easy to remove and replace pipe</li> <li>allows for pipe adjustments during installation</li> <li>economical in use owing to short installation time</li> <li>smoke and water tight</li> <li>excellent sound insulation</li> </ul>	BS, UL, AS FM
	<b>2.5</b> CFS-W SG/ CP 648S Firestop wrap Strip	Precut intumescent graphite strip	<ul style="list-style-type: none"> <li>plastic pipes from 2" (50 mm) up to 6" (160 mm)</li> </ul>	<ul style="list-style-type: none"> <li>simple to use and easy to cut</li> <li>easy to fasten on place</li> <li>long term stability of installation</li> <li>little space required – ideal where pipes run close together</li> <li>ideal for very tight installations</li> <li>long length avoids waste</li> <li>quick and easy closure without the use of a tool</li> </ul>	BS, UL, FM EN, DIN
	<b>2.5</b> CFS-W EL/ CP 648E Intumescent Endless wrap Strip	An intumescent, flexible firestop wrap for plastic and insulated pipe penetrations	<ul style="list-style-type: none"> <li>plastic pipes up to 12" (300 mm)</li> </ul>	<ul style="list-style-type: none"> <li>especially suitable for re-penetration of new cables</li> <li>fast and easy installation</li> <li>no special tools required</li> <li>absolutely dust, fibre, halo gen and solvent free</li> <li>smoke and gas tight</li> <li>immediately functional after installation</li> <li>age tested up to 30 years</li> </ul>	UL, FM, BS EN, DIN
	<b>3.1</b> CFS-PL Firestop plug	Temporary or permanent sealing of single or bunched cables in fire walls and floors	<ul style="list-style-type: none"> <li>single and cable bunches</li> </ul>	<ul style="list-style-type: none"> <li>especially suitable for re-penetration of new cables</li> <li>fast and easy installation</li> <li>no special tools required</li> <li>absolutely dust, fibre, halo gen and solvent free</li> <li>smoke and gas tight</li> <li>immediately functional after installation</li> <li>age tested up to 30 years</li> </ul>	BS, DIN
	<b>3.2, 5.4</b> CFS-BL Firestop brick	Ready-to-use, intumescent flexible brick for temporary or permanent applications	<ul style="list-style-type: none"> <li>multiple penetrations</li> <li>cables and cable trays</li> <li>plastic pipes and metal pipes</li> </ul>	<ul style="list-style-type: none"> <li>especially suitable for re-penetration of new cables</li> <li>easy to install, re-use and re-penetrate</li> <li>easy to cut and shape</li> <li>no special tools required</li> <li>smoke and gas resistant</li> <li>age tested up to 30 years</li> </ul>	BS, UL, FM, DIN, LPCB

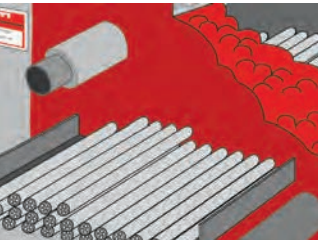
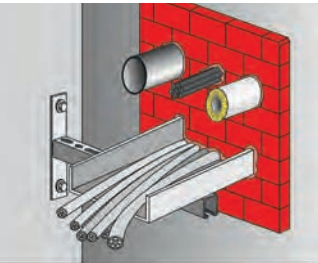
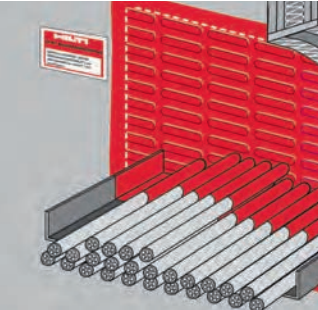
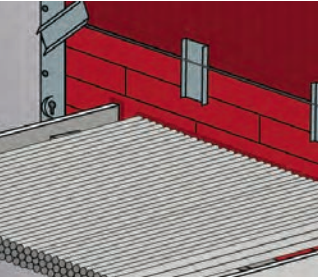
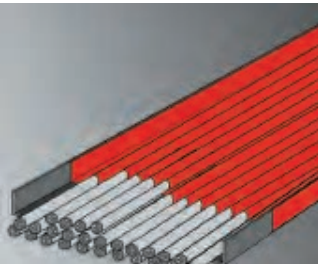
Picture	Product	Description	Application	Benefits	Tested and approved according to
	<b>3.5, 5.5</b> CFS-C U Firestop cushion	Ready-to-use firestop cushion for temporary or permanent sealing of cable and cable tray penetrations	<ul style="list-style-type: none"> <li>multiple penetrations</li> <li>cable bunches and cable trays</li> </ul>	<ul style="list-style-type: none"> <li>excellent for laying new cables</li> <li>easy to install without use of a special tool</li> <li>re-usable</li> <li>tear-resistant and dust-free cushions for dust-free rooms</li> <li>temporary or permanent applications also in drywall</li> <li>age tested up to 30 years</li> </ul>	AS DIN, EN
	<b>2.4, 3.6, 5.3</b> CFS-F SOL/ CP 620 Firestop foam	The versatile seal for a wide range of firestop applications	<ul style="list-style-type: none"> <li>multiple penetrations</li> <li>single cable, cable bunches and cable trays</li> <li>insulated and non-insulated metal pipes</li> <li>combustible pipes in conjunction with fire stop jackets or wraps</li> </ul>	<ul style="list-style-type: none"> <li>wide application range</li> <li>easy to use in poorly accessible openings</li> <li>correct installation through fast explanation in the opening</li> <li>impervious to smoke</li> <li>paintable</li> <li>time saving through few working steps</li> <li>no wastage</li> <li>fully cured in 1 minute</li> <li>age tested up to 30 years</li> </ul>	BS DIN, UL, AS, FM, EN
	<b>2.4, 3.6, 5.3</b> CFS-F FX/ CP 660 Expanding fire seal	Standard solution for all small to medium sized of openings	<ul style="list-style-type: none"> <li>multiple penetrations</li> <li>single cable, cable bunches and cable trays</li> <li>insulated and non-insulated metal pipes</li> <li>combustible pipes in conjunction with fire stop jackets or wraps</li> </ul>	<ul style="list-style-type: none"> <li>very quick and easy to install</li> <li>easy to use in poorly accessible openings</li> <li>3 - phase technology</li> <li>no formwork required</li> <li>impervious to smoke</li> <li>sound insulation tested</li> <li>age tested up to 30 years</li> </ul>	BS, EN
	<b>3.3, 5.1</b> CP 670 Fire safety coated board system	The innovative system for fast, reliable and cost-effective firestopping of wall openings especially large ones	<ul style="list-style-type: none"> <li>multiple penetrations</li> <li>single cable, cable bunches and cable trays</li> <li>insulated and non-insulated metal pipes</li> <li>combustible pipes in conjunction with fire stop jackets or wraps</li> </ul>	<ul style="list-style-type: none"> <li>large penetrations possible up to 5 m high by any length</li> <li>no cracking or delamination during cutting</li> <li>age tested up to 30 years</li> <li>sound insulation tested</li> </ul>	BS, DIN, EN
	<b>6.1</b> CFP-CI/ CP 678 Firestop cable coating	A ready-to-use, water resistant, intumescent cable coating designed to inhibit the propagation of fires along internal electrical cables	<ul style="list-style-type: none"> <li>single cable</li> <li>single cable bundle</li> <li>cable tray</li> <li>air ducts and dampers</li> <li>pipes</li> </ul>	<ul style="list-style-type: none"> <li>simple application</li> <li>high yield and economical</li> <li>easy to clean</li> <li>no derating effects on cables</li> <li>remains flexible when dry</li> </ul>	FM
	<b>6.2</b> CFP-CE/ CP 679A Ablative firestop cable coating	A ready-to use, universal fire retardant ablative coating used on cables laid horizontally or vertically. It can be used for indoor or outdoor applications	<ul style="list-style-type: none"> <li>cable bunches and cable trays</li> <li>cable bunches and cable trays</li> </ul>	<ul style="list-style-type: none"> <li>simple application</li> <li>impermeable to water</li> <li>for outdoor and indoor applications</li> <li>resistant to oil and petrol spills</li> <li>weather proof</li> <li>very flexible when dry</li> </ul>	FM, ABS, DNV

## AGEING RESISTANCE

The question of long-term resistance arises more frequently for fire protection products than for any other construction products. This is to be expected, as fire protection products must retain their functionality throughout the life of a building. Ideally, it would be possible to send the products to an institution, which, after the appropriate tests, could certify them for some 20 to 40 years. Unfortunately, although the aging of plastics and paints, especially colour fastness under the influence of light and temperature or the corrosion of metals, can be easily simulated, there are no basic studies or real-time documentation defining a time-lap test to assess fire protection products. Furthermore, fire protection products are made of very different compounds and therefore cannot be evaluated according to any standardised scheme- for instance, mortar cannot be assessed against the same criteria as silicone sealant. There are standards to evaluate resistance to atmospheric conditions, aging, chemicals, humidity etc. There also are enough institutions ready to test according to these standards, but a statement as to how many years these functions are guaranteed can not be given by any institution. In order to be able to provide our clients with more definite information in this respect, Hilti conducts additional tests of Hilti firestop systems in cooperation with an independent testing institute, simulating an accelerated ageing process. On the basis of the ageing cycles employed in this process as well as experience gained in the field of construction in concrete, it can be assumed that Hilti firestop systems which have passed the above tests have a service life of approximately 30 years from manufacturing date. This expected long-term ageing resistance of Hilti firestop systems, which is given on the basis of the above mentioned tests, depends on a number of factors on which Hilti basically has no influence (e.g. environmental factors such as extreme environmental conditions, chemicals, etc.) and, therefore, are subject to the following conditions which must be strictly observed by the user with regard to the respective Hilti firestop system:

- Strict adherence to the Hilti's operating, setting, installing and other technical instructions
- Rigorous compliance with all other conditions set in the respective specifications during the lifetime of the Hilti firestop systems, in particular with regard to regular control and maintenance as well as to foreseeable use under normal climatic condition in the respective field of application.

## WATER RESISTANCE

Water resistance is understood by Hilti to mean a construction material's ability to withstand the effects on water and moisture not only in the completed, occupied building, but also during the construction phase. During the construction of the carcass of a building, before it is fully sealed and weatherproof, entire floors may be flooded by rainwater. Inadequately hardened sealants may therefore be washed out. These products therefore require a certain degree of rain resistance. Once the firestop products have cured, there is a danger of mould or mildew if a great deal of moisture is present in rooms. If mould develops it must not damage the firestop products. But a certain degree of water resistance must also be provided for openings in a fireproof wall to avoid water damage from water pipe breaks or, in case of fire, water used in extinguishing a fire. Water resistance is therefore an important ancillary element of firestop systems. Hilti firestop systems are not merely tested and approved in accordance with international firestop requirements, but have also been tested for their water-resistant properties according to the valid national and international standards.

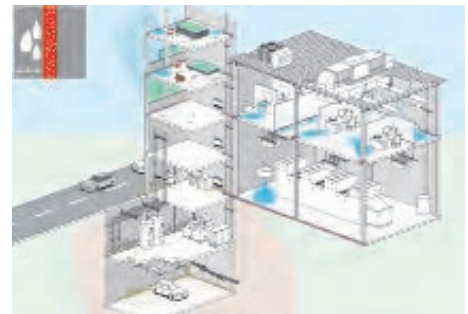

## SMOKE AND GAS TIGHTNESS.

The smoke-and gas-tightness of firestop products is of decisive importance in the event of fire as it may save lives. Moreover, gas-tightness also plays an important role in the thermal insulation of buildings. The requirements to be complied with in terms of smoke-and gas-tightness are laid down in various laws and regulations. Hilti firestop products are not only tested and approved internationally in accordance with the stipulations of passive fire prevention regulations, they are also comprehensively tested to ensure compliance with the standards currently applicable to smoke-and gas-tightness. The Subject of smoke-and gas-tightness is of decisive importance in the following applications.

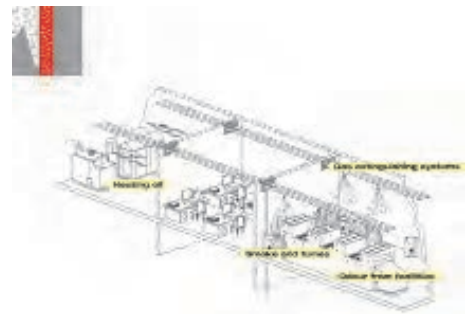

### Smoke-and gas-tightness in the event of fire

The most important point is imperviousness to smoke and fumes. It is the smoke and fumes from fires that cause most deaths and the greatest damage. Accordingly, these must be effectively prevented from spreading in the event of fire. Gas extinguishing systems also have an influence on firestop products, Firstly, these systems cause a significant rise in pressure in the room concerned. Secondly, the extinguishing gas may be harmful to the persons present in the building.

### Gas-and air-tightness of buildings

Within the scope of regulations to promote energy conservation, laws in various countries specify that joints and penetrations in buildings must be air-and gas-tight.

### Protection from critical gases and odours

In many branches of industry, the spread of odours or critical gases must be prevented through use of impermeable materials.

## SOUND INSULATION

Sound insulation in buildings is of great significance to the health and well-being of the occupants. Sound insulation is of particular importance in residential construction because an apartment provides not only a place of rest and relaxation, it also serves to screen off the personal domestic environment from that of neighbours. Specific regulations apply to certain types of buildings such as schools, hospitals, hotels and office accommodation. The sound insulation requirements to be complied with are laid down in directives, standards and regulations throughout the world. Hilti firestop products are not only tested and approved internationally in accordance with the stipulations of passive fire prevention regulations, they are also comprehensively tested to ensure compliance with sound insulation requirements.

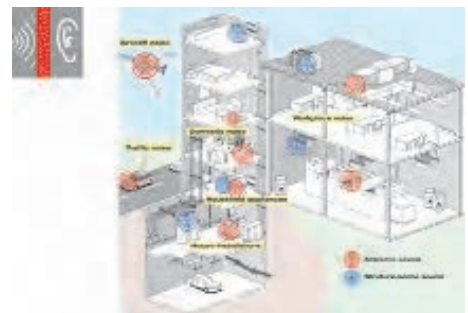









### Airborne sound

"Airborne sound" is the term applied to fluctuations in pressure which spread out in a wave pattern and thereby induce oscillation in the objects or parts of a structure they collide with. Airborne sound in buildings is transformed into structure-borne sound as it strikes walls, floors or ceilings and is passed on through the structure in this form before subsequently radiating into neighbouring rooms as airborne sound. At the same time, the sound becomes weaker as it passes through a wall or ceiling.

### Structure-borne sound

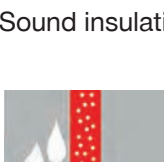
Sound that carries or spreads through a solid object is known as structure-borne sound is usually not perceived as sound or noise but is noticed, if at all, in the form of vibration. It becomes audible, nevertheless, when radiated from the surfaces of the structure and thus transformed into airborne sound. As the energy loss in the transmission of structure-borne sound through solid objects is minimal, the sound can travel over great distances. Accordingly, measures must be taken to isolate living accommodation and other occupied rooms from structure-borne sound.

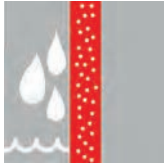
## Mechanical Trade Applications

	Application	Solution	Advantages	Added value
M1	Flammable pipes  having a diameter < 50 mm		FS-ONE Max Intumescent firestop mastic  - comprehensive approval - simple application	Protects against more than just fire  
M2	Flammable pipes  having a diameter 32 mm to 250 mm		CFS-C-EL/CFS-C Firestop jacket/ Collar  - click-fastening - low profile	Smoke- and gas-tightness  
M3	Non-flammable pipes  Non-insulated		CFS-F SOL/CFS-F FX Expanding fire seal  - fast curing - no additional filling necessary - simple installation	Sound insulation  
M4	Air ducts and dampers		CFS-MRG/CP636 Firestop mortar  - no shrinkage when setting or in case of fire - simple application	Water resistance     Ageing resistance*

## Steel & Metal Trade Applications

	Application	
S1	CFS-SP-WB curtain wall joints - high movement capability	

## Electrical Trade Applications

	Application	Solution	Advantages	Added value
E1	Single cables		FS-ONE Max Intumescent firestop mastic - Wide range of approvals - Easy to apply	Protects against more than just fire 
E2	Bunched cables		CFS-F SOL/CFS-F FX Expanding fire seal - Fast curing - No backfilling necessary - Easy to apply	Smoke- and gas-tightness 
E3	Empty conduits / cable trays		FS-ONE Max Intumescent firestop mastic - Wide range of approvals - Easy to apply	Sound insulation 
E4	Special: For frequent retrofitting		CFS-BL Firestop brick / plug - Fast installation - Free from dust and fibers	Electrical resistance 
E5	Special: For temporary seals		CFS-CU Firestop cushion - Reusable - Easy to install - Tear resistant and free from dust Note: limited sound absorption, not electrically insulating	Ageing resistance* 

## Interior Finishing Trade Applications

	Application	
I1	CFS-S ACR/CP 606 building joints - movement capability	

**Firestop products additional testing**

CFS-S SIL/ CP 601S		Fire		Smoke		Air-seal		Acoustic		Age Tested
CFS-S ACR/ CP 606		Fire		Smoke		Air-seal		Acoustic		Age Tested
CFS-SP-WB/ CP 672		Fire		Smoke		Air-seal		Acoustic		Age Tested
FS ONE Max		Fire		Smoke		Air-seal		Acoustic		Age Tested
CFS-F SOL/ CP 620		Fire		Smoke		Air-seal		Acoustic		Age Tested
CFS-F FX/ CP 660		Fire		Smoke		Air-seal		Acoustic		Age Tested
CFS-MRG/ CP 636		Fire		Smoke		Air-seal		Acoustic		Age Tested
CP637		Fire		Smoke		Air-seal		Acoustic		
CFS-EL		Fire	WITH MASTIC	NOT APPLICABLE	NOT APPLICABLE					
CP 638 HS FS		Fire		Smoke		Air-seal		Acoustic		
CFS-C/ CP 643N		Fire	WITH MASTIC	NOT APPLICABLE	NOT APPLICABLE					Age Tested
CFS-CP/ CP 644		Fire	WITH MASTIC	NOT APPLICABLE	NOT APPLICABLE					Age Tested
CFS CID/ CP 680		Fire		Smoke		Air-seal		Acoustic		Age Tested
CFS-W/ CP 648		Fire	WITH MASTIC	NOT APPLICABLE			Acoustic			Age Tested
CP 658		Fire		Smoke						Age Tested
CP 657		Fire		Smoke		Air-seal		Acoustic		Age Tested
CFS-CU		Fire	WITH MASTIC	NOT APPLICABLE			PLANNED			Age Tested
CFS-P PA/ CP 617		Fire					Acoustic			
CP 670		Fire		Smoke		Air-seal		Acoustic		Age Tested
CF 125-50		Fire	WITH MASTIC		Air-seal		Acoustic			



CFS-S SIL/ CP 601S	British Standard BS 476-20	EN 1366-3			
CFS-S ACR/ CP 606	British Standard BS 476-20	EN 1366-3			
CFS-SP-WB/ CP 672	British Standard BS 476-20	EN 1366-4			
CFS-EL		EN 1366-3			
FS ONE Max					
CFS-F SOL/ CP 620	British Standard BS 476-20	EN 1366-4			
CFS-F FX/ CP 660	British Standard BS 476-20	EN 1366-3			
CFS-M RG/ CP 636	British Standard BS 476-20	EN 1366-3			
CP637	British Standard BS 476-20				
CP 638 HS FS	British Standard BS 476-20				
CFS-C/ CP 643N	British Standard BS 476-20	EN 1366-3			
CFS-CP/ CP 644	British Standard BS 476-20	EN 1366-3			
CFS CID/ CP 680	British Standard BS 476-20				
CFS-W/ CP 648	British Standard BS 476-20	EN 1366-3			
CP 658	British Standard BS 476-20				
CP 657	British Standard BS 476-20				
CFS-CU		EN 1366-3			
CFS-P PA/ CP 617	British Standard BS 476-20	EN 1366-3			
CP 670	British Standard BS 476-20	EN 1366-3			
CF 125-50	British Standard BS 476-20				

## CFS-S SIL/CP 601S Elastic firestop sealant

### Product description

A silicone based firestop sealant that provides maximum movement in fire rated joint applications and metal pipe penetrations. Providing fire ratings of up to 4hrs in various applications.

### Areas of application:

- Expansion joints
- HVAC penetrations
- Metal pipes
- Top of wall joints

Sealing expansion joints where stringent fire prevention requirements must be met. Insulation and integrity tested up to 4 hours for walls and floors. Sealing penetrations for metal pipes with movement. Insulation and integrity tested up to 4 hours for floors and 3 hours for walls.

### Product features

- Halogen and solvent free
- Weather and UV resistant

### Base materials

Masonry, Metal, Concrete, Glass  
(Wall and floor thickness >100mm)  
(Joint widths from 6-150mm)  
(Joint widths up to 50mm with PE rod)

### Approvals Internationally tested and approved

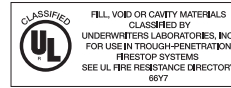

# EN 1366-3

**Other tests include :** ASTM E 814 : ASTM C 920 : ASTM E 1399 : ASTM E 90-97 : ASTM E 84-96 : UL 2079 : UL 1479 : ISO 11600

### Recommendations

- Can be used in conjunction with a suitable backing material:
  - Non flammable mineral wool (min. 100kg/m<sup>3</sup> per BS).
  - Hilti CF125-50 fire rated backing foam for construction joints only\*

\*Please note fire rating will be reduced.

### Storage

- Store only in the original packaging in a location protected from moisture at a temperature of 5°C to 25°C.
- Observe expiry date on top of cartridge.

## CP 601S Elastic firestop sealant



Ordering designation	Content per can/cartridge	Volume per unit	Sales pack quantity	Item number
CFS-S SIL/CP 601S 310ML white	310 ml	310 ml	1 pc	310633
CFS-S SIL/CP 601S 310ML grey	310 ml	310 ml	1 pc	310635

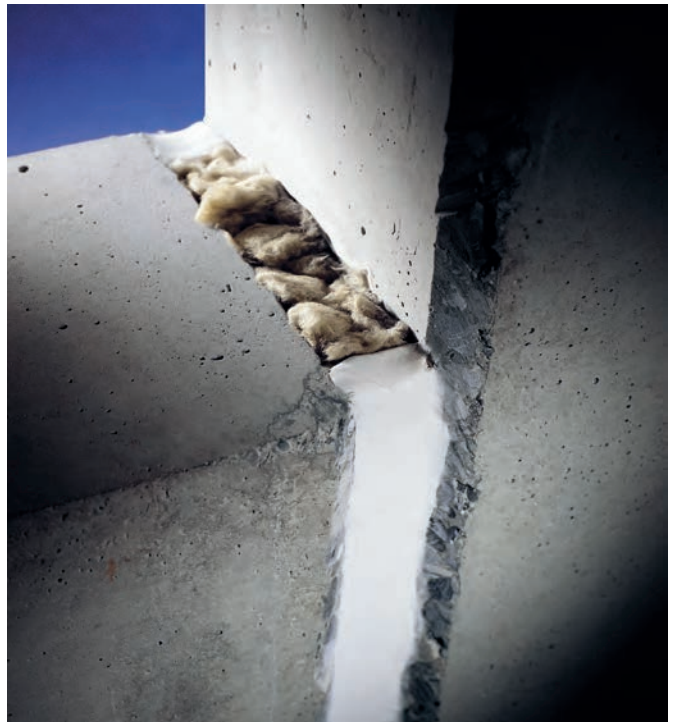

### Key applications & advantages

- Expansion or stretched connection joints in fire compartment walls and floors
- Uninsulated metal pipes in penetrations through fire compartment walls and floors
- Acoustic insulation of pipes
- Silicone-based, provides maximum movement absorption in fire-rated joint applications and pipe penetrations
- Good adherence without primer

## CFS-S SIL/CP 601S Elastic firestop sealant

### Technical data

Approx. density	1510 kg/m <sup>3</sup>
Chemical basis	Neutral elastic silicone
Shelf life <sup>1)</sup>	12 Months
Approx. curing time <sup>2)</sup>	2 mm/3 days
Base materials	Masonry, Metal, Concrete, Glass
Application temperature range	5 - 40 °C
LEED VOC	3 g/l
Movement <sup>3)</sup>	± 25% (ISO 11600)

<sup>1)</sup> at 77°F/25°C and 50% relative humidity; from date of manufacture

<sup>2)</sup> at 75°F/24°C, 50% relative humidity

<sup>3)</sup> according to HTC 1250

### Application

- Joint sides must be sound, dry and free from dust, oil or grease.
- Check whether a primer is required for the substrate. Check with Hilti application engineering for recommended primer if needed.
- Apply CFS-S SIL/CP 601S to the joint.
- Insert backfill of non flammable mineral wool or PE Rod.
- Smooth firestop sealant with smoothing agent or soap solution before the skin forms.
- Remove CFS-S SIL/CP 601S firestop sealant before it cures using white spirit. Once cured, it can only be removed mechanically.

### Safety precautions

- Please refer to MSDS data sheet available as a download from the Technical Library on the Hilti web site at [www.hilti.co.za](http://www.hilti.co.za)

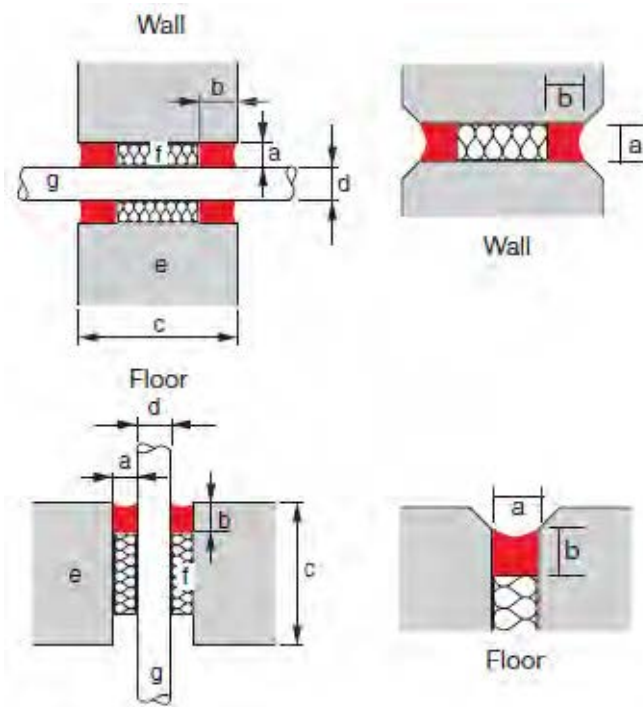

Around the metal pipe - ducts - joints

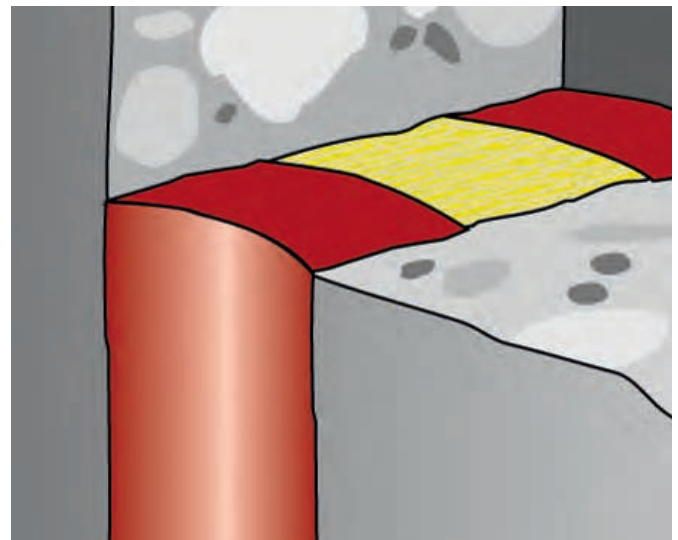

### Consumption guide

- Consumption guide values are given as joint length in meters per cartridge.

b = Joint depth	a = Joint width (mm)				
	6	10	20	30	100
6 mm	8.6	5.2			
10 mm			1.6		
15 mm				0.7	0.1

### Backfilling per BS

Max. joint width	Base material	Backfilling	Fire rating per BS 476	
			Insulation	Integrity
15 mm	Gas concrete	Mineral wool	4h	4h
30 mm	Gas concrete	Mineral wool	4h	4h
100 mm	Gas concrete	Mineral wool	4h	4h
10 mm	Masonry wall	PE Rod	4h	4h
30 mm	Masonry wall	PE Rod	4h	4h
50 mm	Masonry wall	PE Rod	4h	4h
10 mm	Concrete floor	PE Rod	4h	4h
30 mm	Concrete floor	PE Rod	4h	4h
50 mm	Concrete floor	PE Rod	4h	4h

### CFS-S SIL/CP 601S

#### Installation instructions for metal pipes per BS Dimensions

The following dimensions must be observed when using CFS-S SIL/CP 601S elastic firestop sealant.

	wall (mm)	floor (mm)
a - Joint width min.	10	10
Joint width max.	40	40
b - Joint depth	20	20
c - Min. thickness of Building component	100	120
d - Max. pipe Ø	160	160
e - Base Material	Concrete, Masonry, Glass, Metal	
f - Mineral Wool	Min. 100kg/m <sup>3</sup>	
g - Metal Pipe	Clean, dry and free from grease and oil	
h - CP 601S	Apply both sides	

## CFS-S ACR/CP 606 Fire resistant joint filler

### Product description

An acrylic based firestop mastic that offers movement capabilities and excellent acoustic rating in fire rated joint applications. Provides up to 4hrs integrity in various applications when tested to BS476 Part 20.

### Areas of application:

- Sealing header joints
- Sealing drywall partition connections
- Sealing joints to CFS-CT/CP 670 firestop safety board
- Metal pipes
- Rigid and low movement joints  
Tested on metal pipes in walls, floors and dry-wall.

### Product features

- Silicone free
- Halogen and solvent free
- UV resistant

### Base materials

Concrete, Masonry, Drywall  
Steel, Porous concrete  
(Wall and floor thickness from 100mm)  
(Joint widths from 6-100mm)



### Key applications & advantages

- Sealing rigid or low-movement ceiling/wall joints, widths from 6 to 30 mm
- Sealing cable tray penetrations
- Sealing metal pipe penetrations
- Good adherence without primer
- Smoke, fume and water resistant

### Approvals Internationally tested and approved

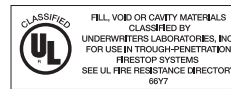

# EN 1366-3

**Other tests include :** ASTM E 814 : ASTM C 920 : ASTM E 1399 : ASTM E 90-97 : ASTM E 84-96 : UL 2079 : UL 1479 : ISO 11600

### Recommendations

- Can be used in conjunction with a suitable backing material:
  - Non flammable mineral wool (min. 100kg/m<sup>3</sup> per BS).
  - Hilti CF125-50 fire rated backing foam for construction joints only\*

\*Please note fire rating will be reduced.

### Storage

- Store only in the original packaging in a location protected from moisture at a temperature of 5°C to 25°C.
- Observe expiry date on top of cartridge.

### CP 606 Fire resistant joint filler



Ordering designation	Content per can/cartridge	Volume per unit	Sales pack quantity	Item number
CFS-S ACR/CP 606 310ml white	310 ml	310 ml	1 pc	209625
CFS-S ACR/CP 606 5L white	5000 ml	5000 ml	1 pc	209638

## CFS-S ACR/CP 606 Fire resistant joint filler

### Technical data

Colour	White
Approx. density	1600 kg/m <sup>3</sup>
Chemical basis	Water-based acrylic dispersion
Shelf life <sup>1)</sup>	24 Months
Approx. curing time <sup>2)</sup>	3 mm/3 days
Base materials	Concrete, Masonry, Drywall, Steel
Application temperature range	5 - 40 °C
LEED VOC	75 g/l
Movement <sup>3)</sup>	±12.5% (ISO 11600)

<sup>1)</sup> at 77°F/25°C and 50% relative humidity; from date of manufacture

<sup>2)</sup> at 75°F/24°C, 50% relative humidity

<sup>3)</sup> according to HTC 1250

### Application

- Joint sides must be sound, dry and free from dust, oil or grease.
- Check whether a primer is required for adhesion to the substrate.
- In walls apply CFS-S ACR/CP 606 to both sides of the joint.
- Insert backfill of non-flammable mineral wool (at least 100 kg/m<sup>3</sup> + melting point > 1000°C), Hilti CF 125-50 foam or PE backing rod.
- Smooth firestop sealant with water before the skin forms.
- Remove CFS-S ACR/CP 606 firestop sealant before it cures using water. Once cured, it can only be removed mechanically.

### Joint side material/primer recommendations

- To improve adhesion of firestop sealant if the substrate is porous and absorptive, mix CP 606 with water and apply as a primer on base material.
- The compatibility of the sealant with any encountered paints must always be checked. In particular, this concerns dispersion paint systems and alkyd resin systems that can be diluted in water.
- Checks of compatibility must be repeated at reasonable intervals because the chemical composition of paint systems may change.

### Chemical resistance

- Normally, there is no need for resistance to chemicals with the applications recommended by Hilti.
- Unprotected acrylic sealants have only slight resistance to chemicals.
- Please contact the Technical Advisory Service or your local Fire Protection Specialist or the nearest Hilti center if special requirements for chemical resistance have to be met.

### Safety precautions

- Please refer to MSDS data sheet available as a download from the

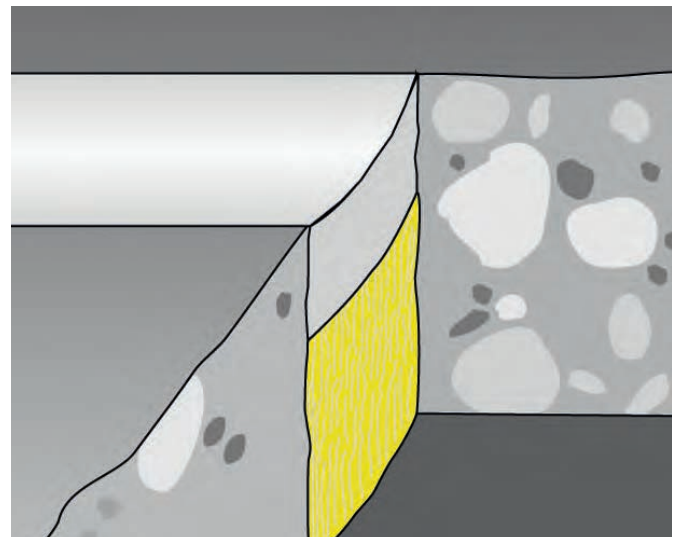

### Dimensions

- The following dimensions must be observed when using CFS-S ACR/CP 606 fire resistant joint filler.

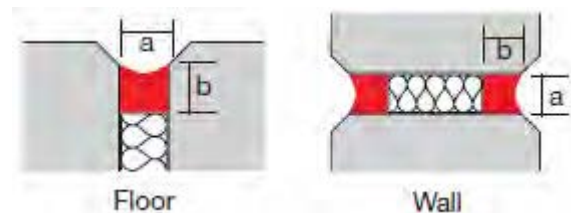

### Consumption guide

- Consumption guide values are given as joint length in meters per cartridge.

b = Joint depth	a = Joint width (mm)				
	6	10	20	30	100
6 mm	8.6	5.2			
10 mm			1.6		
15 mm				0.7	0.1

### Backfilling per BS

Max. joint width	Base material	Backfilling	Fire rating per BS 476	
			Insulation	Integrity
6 mm	Gas concrete	Mineral wool	4h	4h
15 mm	Gas concrete	Mineral wool	4h	4h
20 mm	Gas concrete	PE 24 mm	130 min.	4h
20 mm	Gas concrete	PU foam CF 125-50	208 min.	4h
30 mm	Gas concrete	Mineral wool	216 min.	4h
30 mm	Steel-steel	Mineral wool	36 min.	4h
65 mm	Dry wall/concrete (Top of wall)	Mineral wool	136 min.	4h

The above applications are not exhaustive. For further details please contact your local Hilti representative

## CFS-SP-WB Firestop joint spray

### Product description

A sprayable fire rated mastic for use in curtain wall edge of slab and head of wall joints where maximum movement is required. Providing fire rated protection of up to 3 hours.

### Areas of application:

- Curtain wall/edge of slab
- Top of wall joints
- High movement expansion joints
- Joints in either walls or floors

### Product features

- Contains no halogens, solvents or asbestos
- Water based, easy to clean
- Sprayable or may be applied by brush
- Bonds well to most substrates

### Base materials

Concrete, Masonry

Walls assemblies tested up to 3 hours

Walls 80mm - 175mm thick

Curtain wall assemblies tested up to 2 hours

### Storage

- Store only in the original packaging at temperatures 5°C to 37°C.
- Observe expiration date on packaging.

### Approvals Internationally tested and approved



**Other tests include :** ASTM E 1399 : ASTM E 84 : UL 2079

### Benefits for curtain wall installations

If your company installs curtain wall systems, you can't afford to ignore this firestop solution. Your clients may be unaware that traditional, foilfaced seals do not meet the current regulations. Using Hilti Speed Spray not only makes the building safe, it could save you money and reduce your client's Insurance risk.

For examples of how enlightened companies have already benefited, refer to the case studies at [www.hilti.co.za](http://www.hilti.co.za)

### Installed cost benefits

- Up to 5 times faster
- Only 2 components, mineral wool and Speed Spray
- No drilling and fixing for impaling brackets
- No tapes or mastics

### Building regulations

England and Wales

- Part B: Smoke and flame / Part E: Acoustics / Part L: Air Seal Scottish Technical Handbooks (Domestic and Non Domestic)
- Part 2: Fire / Part 5: Noise

### CFS-SP-WB Firestop Joint Spray

**\*ON DEMAND ITEM - Please ask your field engineer or account manager for more information (subject to change)**



### Key applications & advantages

- Simple use and application
- Smoke, gas and water tight
- Approved for infinite linear gap lengths
- Meets LEEDTM requirements for indoor environmental quality credit

### Benefits for your clients

Insurers set premiums based on their exposure to risk. Traditional foil-faced systems can't accommodate the distortion which occurs during a fire

Hilti Speed Spray has been proven in over 14 full-scale curtain wall fire tests.

### Sustainability

- Fit and forget - minimum 30 year life
- No VOCs (Water-based)
- Age tested to maintain fire rating and elasticity

### CFS-SP-WB Estimation Table

Joint width (mm)	With overlap 12.5mm either side (mm)	Meters per 19 litres pail (meters)
25	50	110
50	75	75
75	100	55
100	125	45
150	175	35
200	225	30

## CFS-SP-WB Firestop joint spray

### Technical data

Density	1.27 g/cm <sup>3</sup>
Color	Red
Application Temperature Range	5°C - 40°C
Working time	30-45 min
pH Value	~ 8-9
Cure Time (at 23°C/50% r.H)	72-120 h
Movement	up to 50 %
Temperature resistance temperature range	-40°C - 80°C
Chemical basis	Water-based latex dispersion

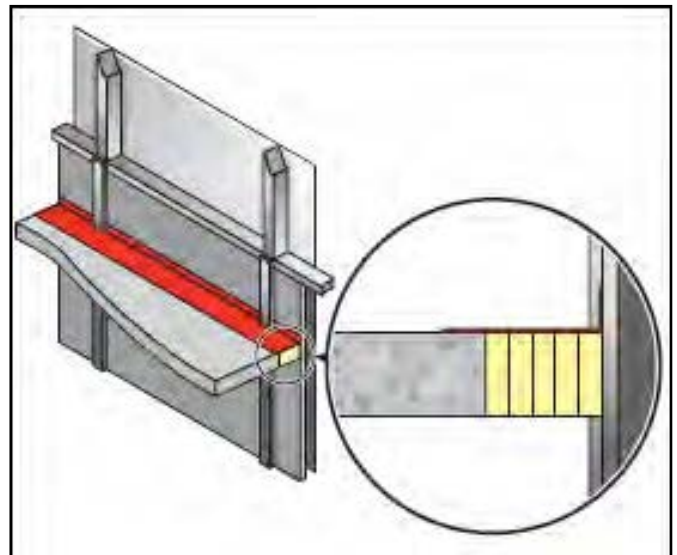

### System Advantages

- Maximum flexibility, exceeds 500cycle requirements (Class II & III Approval) (ASTM E 1399 & UL 2079)
- Proven to resist seismic type cycling movements, as per ASTM E 1966 test procedure
- Quick and easy installation with the Spray Tech EP2510 Sprayer saves you time and money
- Movement capability has been tested in real cladding system applications
- Bonds extremely well to most materials
- Age tested to 30years to recognise test standards
- Integrated smoke seal - due to latex characteristics and therecommended overlapping on installation

### Installation Instructions

- Before handling, refer to the MSDS for safely information. This is available as a download from [www.hilti.co.uk/fspray](http://www.hilti.co.uk/fspray)
- Wear suitable gloves and eye protection.
- Keep out of the reach of children.completed seal should be left undisturbed for 48 hours.

### Opening

- 1 Clean the opening. Surfaces to which CFS-SP-WB will be applied should be cleaned of loose debris, dirt, oil, moisture, frost and wax.

### Installer information



1 Clean opening



2 Pack in mineral wool



3 Spray on CFS-SP-WB



4 Allow CFS-SP-WB to cure.

### Omega Point Test

- Omega Point Laboratories test products intended for curtain wall systems in actual cladding applications



### Application of firestop spray

- 1 Mineral wool packing  
Install the prescribed back filling material type and depth to obtain desired rating.
- 2 Application of firestop spray  
Apply CFS-SP-WB required depth in order to obtain the desired rating.  
Make sure CFS-SP-WB contacts all surfaces and overlaps specified amount beyond all surrounding surfaces.  
Spray Tech EP2510, Benron EZ-Tex Sprayer and Graco Texspray  
Compact HP pumps have been successful in applying CFS-SP-WB Firestop Joint Spray.  
Contact Hilti Technical Support for more information.
- 3 Curing of firestop spray. Allow 3 to 5 days (@ 23°C and 3mm depth) for CFS-SP-WB to fully cure
- 4 For maintenance reasons, joint seal could be permanently marked with an identification plate. In such a case, mark the installation plate and fasten it in a visible position next to the seal.

The above applications are not exhaustive. For further details please contact your local Hilti representative

## FS-ONE Max

### High performance Intumescent firestop sealant

#### Product description

Intumescent (expands when exposed to fire) firestop sealant that helps protect combustible and non-combustible penetrations for up to 4 hours fire rating.

#### Areas of application:

- Steel (<30"), copper (<6"), cast iron (<30") and EMT pipes.
- Insulated steel and copper pipes.
- Cable bundles.
- Closed or vented plastic pipes.
- HVAC penetrations.

#### Product features

- Expanding in fire protection pipes and cable penetrations.
- Smoke, gas and water tight.
- Halogen and solvent free.
- Odourless, water based, easy to clean.
- High fire rating properties.
- Sealing around compressible and non-compressible penetration in fire-rated construction.

#### Base materials

Concrete, masonry, drywall and wood floor assemblies.

Wall and floor assemblies rated up to 4 hours.

#### Approvals Internationally tested and approved

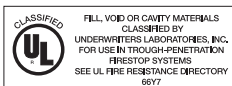

Other tests include : UL 1479 : ASTM E 814 : ASTM E 84 : ASTM E 90-97

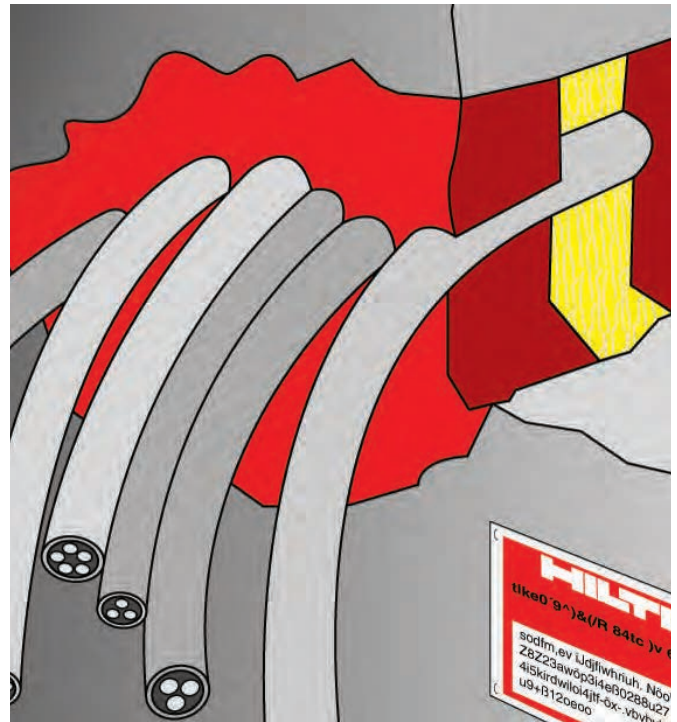

#### Key applications & advantages

- Protects more than 95% of all typical firestop application.
- Easy to work with and fast cleanup.
- Can be repenetrated when laying new cables.
- Can be painted.
- Meets LEEDTM requirements for indoor environmental quality credit

## FS-ONE High Performance Intumescent firestop sealant



Ordering designation	Sales pack quantity	Item number
FS-One Max	1 pc	2101534
Firestop sealant FS-ONE MAX	1 pc	2101535



## Opening

1. Clean the opening. Surfaces to which FS-ONE will be applied should be cleaned of loose debris, dirt, oil, moisture, frost and wax. Structures supporting penetrating items must be installed in compliance with local building and electrical standards.

## Application of firestop sealant

2. Install the prescribed backfilling material type and depth to obtain the desired rating (if required). Leave sufficient depth for applying FS-ONE.
3. Application of firestop sealant: Apply FS-ONE to the required depth in order to obtain the desired fire rating. Make sure FSONE contacts all surfaces to provide maximum adhesion. For application of FS-ONE use a standard caulking gun, foil pack gun, bulk loader and bulk gun. With FS-ONE buckets, Graco type sealant pumps may be used. (Contact pump manufacturer for proper selection).
4. Smoothing of firestop sealant: To complete the seal, tool immediately to give a smooth appearance. Excess sealant, prior to curing, can be cleaned away from adjacent surfaces and tools with water.
5. Leave completed seal undisturbed for 48 hours.
6. For maintenance reasons, a penetration seal should be permanently marked with an identification plate and fastened in a visible position next to the seal.

## Notice about approvals

- Check that the penetration has been sealed according to the specified drawing in the UL Fire Resistance Directory or Hilti North American Firestop Manual. For further advice, please contact Hilti customer service. Refer to Hilti product literature and UL Fire Resistance Directory for specific application details.

## Installation instructions for FS-ONE

### Cable installation

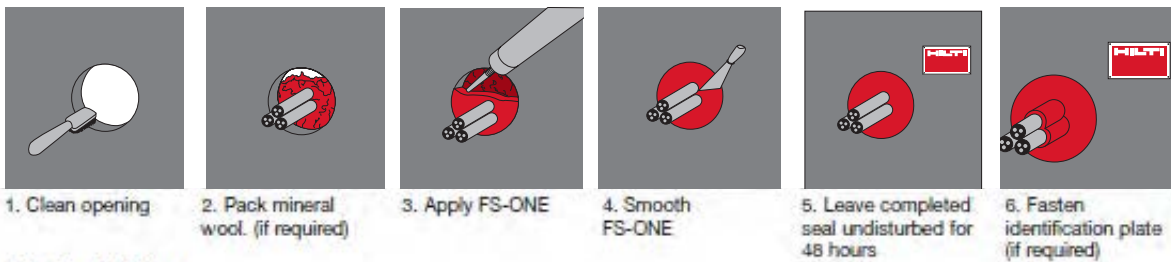

### Pipe installation

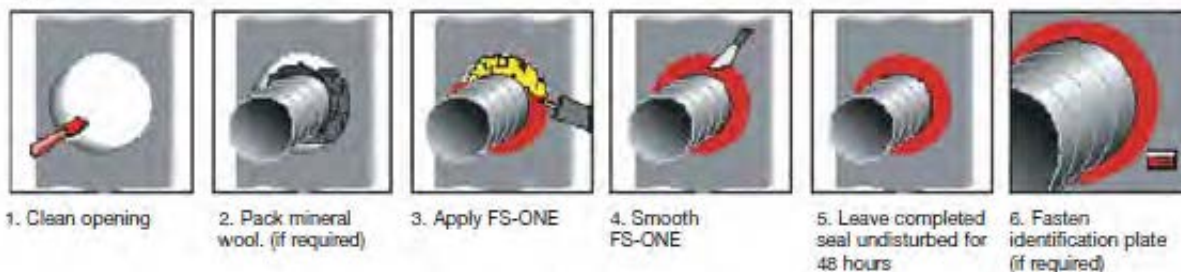

## Technical data

<b>Chemical basis:</b>	water-based intumescent acrylate
<b>Density:</b>	1.5 g/cm <sup>3</sup>
<b>Colour:</b>	red
<b>Curing time: at 23°C/50% relative humidity</b>	approx. 4mm/3days
<b>Movement capacity:</b>	± 5%
<b>Intumescent:</b>	Yes
<b>Base materials</b>	Concrete, Brick, Masonry, Metal, Gypsum
<b>Application temperature:</b>	+5°C to 40°C
<b>Shelf time: at 23°C/50% relative humidity</b>	9 months

## Safety precautions

- Before handling, read the product and Material Safety Data Sheet for detailed use and health information.
- Keep out of the reach of children.
- Wear suitable gloves and eye protection.

## Storage

- Store only in the original packaging in a location protected from moisture at temperatures between 45°F (5°C) and 86°F (30°C).
- Observe expiration date on the packaging.

## Not for use...

- High movement expansion joints.
- Underwater.
- On materials where oil, plasticizers or solvents may bleed i.e. impregnated wood, oil based seals, green or partially vulcanized rubber.
- In any penetration other than those specifically described in this manual or the test reports.

## CFS-F SOL/CP 620 Firestop foam

### Product description

An innovative expanding product offering firestopping solutions for complex applications in small to medium sized openings. Providing fire ratings tested p to 3 hours.

### Areas of application:

- Sealing small-medium sized openings (wall and floor)
  - Permanent fire seal for cables and cable trays
  - Permanent fire seal for non combustible pipes
  - Permanent fire seal for combustible pipes when used in conjunction with CP643N, CP644 or CP648
  - Permanent fire seal where cables, steel, copper cast iron or plastic pipes pass through the same opening
- \*Tested BS 476 integrity 2hrs : UL 1479 3hrs

### Product features

- Up to 6 times expansion
- Re penetrable
- Cures within 60 seconds

### Base materials

Concrete, Masonry, Drywall



### Key applications & advantages

- Single cables, cable bundles and cable trays
- Metal pipes
- Multiple and mixed penetrations
- Innovative firestopping solution for complex and difficult-to-reach applications
- Virtually impervious to smoke

### Approvals Internationally tested and approved

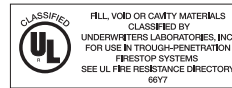

# EN 1366-3

Other tests include : UL 1479 : ASTM E 814 : ASTM E 84 : ASTM E 90-97 : DIN 4120 Part 9

### Storage

- Store only in the original packaging in a location protected from moisture at a temperature of 5°C to 25°C.
- Observe expiry date on top of cartridge.

## CFS-F SOL/CP 620 Firestop foam



Ordering designation	Content per can/cartridge	Sales pack quantity	Item number
CFS-F SOL/CP 620	300 ml	1 pc	2025083

## CFS-F SOL/CP 620 Firestop foam

### Technical data

Color	Red
Application Temperature Range	5°C - 40°C
Min. curing time ready to cut	2 min
Foam Yield	1.9 l
Tack free time (at 23°C / 50% r.H.)	35 s
Temperature resistance temperature range	-30°C - 100°C
Building material class	B1
Shelf life (@73°F/23°C and 50% relative humidity)	9 months

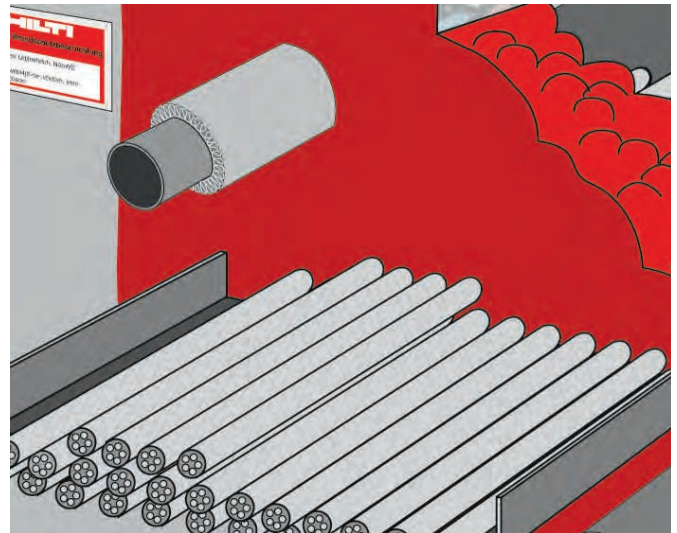

### Application

- 1-4 Prepare dispenser and cartridges as shown above. The fire seal from the first few strokes of the dispenser should be discarded until the fire seal in the mixer has a constant red colour.
- 5 Apply the CFS-F SOL/CP 620 in the opening.
  - When dispensed slowly, the fire seal escaping from the mixer is already slightly expanded. This makes it easier to build up the fire seal.
  - When dispensed quickly, the consistency of the fire seal is more liquid. The fire seal then flows better between the cables.
  - Begin applying CFS-F SOL/CP 620 at the back of the opening and then work towards the front.

Note: The fire seal becomes warm for a short time after application. Fill the opening completely with CFS-F SOL/CP 620 Expanding Fire Seal.
- 6 For maintenance reasons, a penetration seal can be permanently marked with an installation plate. In such cases, mark the installation plate and fasten it in a visible position next to the seal.

- Use a suitable tool to create an opening (screwdriver, drill bit etc.). Push the cable or pipe through and then seal the remaining opening carefully with CFS-F SOL/CP 620. Notes
- The extension pipe can be fitted when working on difficult-to-reach openings.
- The fire seal can be cut back to no less than the minimum specified installed depth.
- Pieces of cured fire seal which have been cut off can be laid in the next opening and fresh fire seal applied around these.

### Framing

(Thickness of wall less than 145 mm per BS)

When the wall has a thickness of less than 145mm and a 2 hours fire rating is required, a frame of plasterboard strips must be attached around the opening in order to achieve a fire seal depth of 145 mm (minimum wall thickness 120 mm per BS).

Example – 120 mm drywall thickness:

The height of the strips forming the frame must be selected so that the fire seal has a thickness of 12.5mm either side of the installation thus achieving 145mm overall thickness of CFS-F SOL/CP 620.

### Re-installing cables or pipes

- Additional cables or pipes can be installed later without difficulty.

### Instructions for applying CFS-F SOL/CP 620



1 Hold the cartridge with the nozzle pointing upwards and unscrew the cap. Do not point towards people.

2 Fit the mixer and screw securely.

3 Release the dispenser and pull back the piston rod.

4 Insert the cartridge in the dispenser.

5 Apply CP 620, building up a seal by working from the back towards the front.

6 Attach the installation plate (if required).

The above applications are not exhaustive. For further details please contact your local Hilti representative

## CFS-F FX/CP 660 Expanding Fire Seal

### Product description

An innovative expanding product offering firestopping solutions for complex applications in small to medium sized openings.

### Areas of application:

- Permanent firestop seals in small and medium-sized openings  
(optimum size range: 100 x 100 mm to 300 x 300 mm)
- Cable trays, bunched and single cables
  - Openings accommodating pipes and cables
  - Plastic pipes (can also be installed as a system in conjunction with Hilti firestop jackets and firestop wrap)
  - Metal pipes (uninsulated or with flammable or non-flammable insulation)  
(National approvals must be observed.)

### Base materials

Concrete, Masonry, Drywall

### Approvals Internationally tested and approved

**British Standard**  
**BS 476**



**EN 1366-3**

### Storage

- Store only in the original packaging in a location protected from moisture
- Observe expiry date on top of cartridge.



### Key applications & advantages

- 3-phase technology with optimum application characteristics (easily shapeable foam)
- Easy installation without need for formwork or other aids ispersers
- Safety first: CFS-F FX/CP 660 complies with the requirements of international fire protection directives
- Neat and tidy application
- Very quick and easy to install - a reliable firestop seal with only one product
- Easy subsequent installation of additional cables
- Outstanding sound insulation properties thanks to flexible foam structure
- Smoketightness and firestopping with one system

**CFS-F FX/CP 660 Expanding fire seal - \*ON DEMAND ITEM - Please ask your field engineer or account manager for more information (subject to change)**



Ordering designation	Content per can/cartridge	Sales pack quantity	Item number
CFS-F FX/CP 660	300 ml	1 pc	2025083

## CFS-F FX/CP 660 Expanding Fire Seal

### Technical data

Color	Red
Foam Yield	2.1
Max. storage temperature	25°C
Building material class	B2
Shelf life (@73°F/23°C and 50% relative humidity)	9 months
Application temperature range	5°C - 40°C
Temperature resistance temperature range	-30°C - 60°C

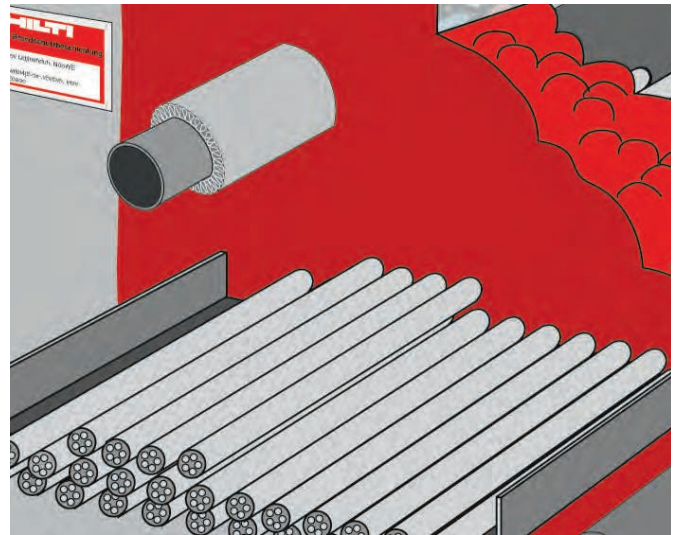

## Main applications

### Trade Electrical

#### Cable penetrations



- Small and medium-sized openings
- Also suitable for conduits
- Ideal for openings of 150x150 mm to 300x300 mm

- Special approvals for openings accommodating pipes and cables and for use with CP 657

Trade: Plumbing, heating, air conditioning

#### Pipe penetrations



- Metal pipes without insulation, with non-flammable insulation up to 168 mm and flammable insulation up to 114.3 mm
- Plastic pipes with Hilti firestop jacket or firestop wrap up to 110 mm
- Gap around the pipe can be filled easily without need for backfilling

Trade: Interior finishing  
Cable and pipe penetrations



- Penetrations in drywall partitions, 100 mm and larger
- No formwork required

- Ideal for openings in the 100 x 100 mm to 250 x 250 mm range

(National approvals must be observed.)

#### Safety precautions

- Please refer to MSDS data sheet available as a download from the Technical Library on the Hilti web site at [www.hilti.co.uk](http://www.hilti.co.uk) / [www.us.hilti.com](http://www.us.hilti.com)

## 3-phase technology.

This intumescent firestop foam is very easy to apply. Installation is a 3-phase procedure:

### 1. Mixing



The two components are combined as they are dispensed. A specially-designed mixing nozzle ensures even mixing of both components and thus optimum foam quality at all times.

### 2. Expansion



The firestop foam begins to expand after about 30sec. and reaches approx. 6 times its original volume.

### 3. Curing



The foam becomes shapeable after approx. 5 min. and can be cut after about 10 min. Thanks to the foam's flexible structure, single cables can be retrofitted easily without drilling or cutting.

## CFS-M RG/CP 636 Firestop mortar

### Product description

A fire resistant, cement based mortar with thermal insulating properties for sealing small to large sized openings where further penetrations may be required. Providing integrity of up to 4 hours.

### Areas of application:

- Permanent fire seal for cables and cable trays
- Permanent fire seal for ductwork
- Permanent fire seal for metal pipes
- Tested on wall > 100mm and floors > 150mm per BS

### Product features:

- High yield
- Stiff (forms not always required)
- Contains no asbestos, phenol or halogen constituents
- Good adhesion to steel, concrete and masonry

### Base materials

Concrete, Porous Concrete, Masonry  
Walls with a max. opening of 2000mm x 1000mm per BS  
Floors with a max. opening of 600mm x 1000mm per BS

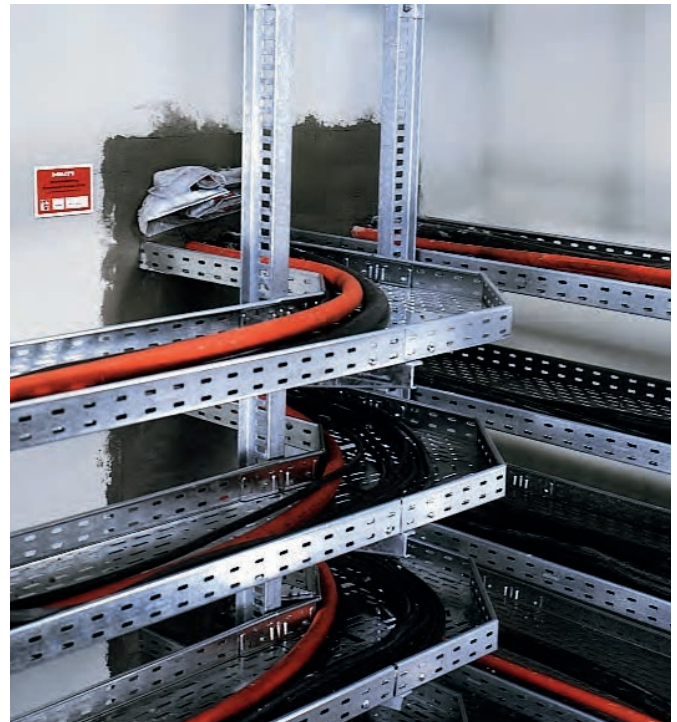

### Key applications & advantages

- Permanent firestopping of cables, cable trays, and non-combustible pipes in medium to large wall and floor openings
- Single, multiple and mixed penetrations
- Medium to large multiple penetrations in concrete and masonry in combination with other products
- Excellent application characteristics
- Easy to install with trowel or commercially available pumps thanks to adjustable consistency

### Approvals Internationally tested and approved

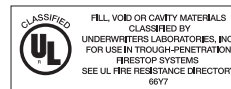

# EN 1366-3

Other tests include : UL 1479 : ASTM E 814 : ASTM E 84 : ASTM E 90-97 : DIN 4120 Part 9

### Recommendations

- Mix the mortar in the ratio of 3:1 (mortar to water by volume) Stir the mortar into the water
- Apply the mixed mortar in the penetration manually
- The mixed mortar is stiff, but forms are still required for large penetrations
- Hilti firestop products approved for making provisions for the installation of cables at a later date: firestop cushion, CFS-BL firestop bricks, CP611A firestop intumescent mastic.

### Storage

- Observe expiry date on packaging.



## CFS-M RG/CP 636 Firestop mortar

Ordering designation	Weight	Sales pack quantity	Item number
CFS-MRG/CP 636 20KG	20 kg	1 pc	334897

## CFS-M RG/CP 636 Firestop mortar

### Technical data

Dry density	800 kg/m <sup>3</sup>
Color	Grey
Application Temperature Range	5°C - 40°C
Mix ratio (Mortar to Water by Weight)	3:1
Temperature resistance temperature range	-40°C - 400°C
Building material class	A1
Shelf life (@73°F/23°C and 50% relative humidity)	12 months
Wet density	1100 kg/m <sup>3</sup>
Compressive strength	2.9 N/mm <sup>2</sup>

### Opening

- Clean and pre moisten surfaces
- Cables and cable supporting structures must be installed in compliance with local building and electrical standards.

### Placing the firestop mortar

#### a) Mix the mortar

- Add mortar to water in a ratio of 3:1 (mortar to water by volume). Stir the mixture thoroughly with, for example, a Hilti TE-MP/TE 16M paddle. The mix ratio of CP 636 to water determines the desired consistency (stiffness).
- Do not use any other binders or additives/aggregates.

#### b) Apply the mortar

- Use forms on one or both sides for larger penetrations. Apply mixed mortar in the opening using a trowel or a pump and compact it. Make sure all gaps and spaces are completely filled and closed.
- CP 611A/FS-ONE can be used in conjunction with mortar. In such a case, apply CP 611A to the cables over a width of approx. 30 mm and 5 mm thick to obtain 4 hours rating. Fill gap between cables with CP 611A. Application of the mortar can be continued immediately after CP 611A has been applied.

#### c) Changing cables

CFS-BL firestop cushion, CFS-BL firestop brick and CP 611A intumescent firestop mastic can be incorporated in the initial seal when additional cables may be installed at a later date. In doing so, attention must be paid to the maximum permitted size of the reserved opening.

- CP 651 opening max. 250 x 170 mm in 150 mm
- CP 655 opening max. 200 x 100 mm in 150 mm
- CP 611A opening max. Ø160 mm in 150 mm

### Dimensions per BS

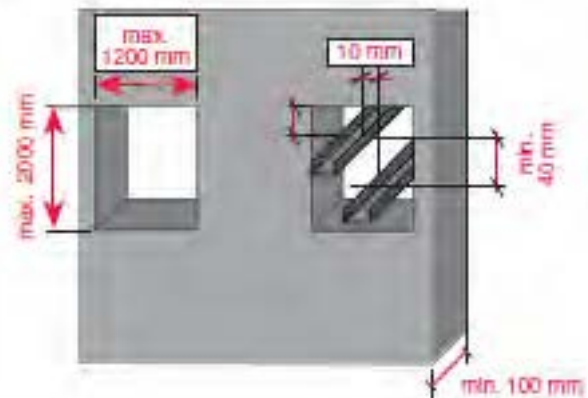

### Safety precautions

- Please refer to MSDS data sheet available as a download from the Technical Library on the Hilti web site at [www.hilti.co.za](http://www.hilti.co.za)

The following dimensions must be observed when using CP 636 firestop mortar per BS.

	Wall	Floor with CP 611A included
Min. building component thickness	150 mm	100 mm
Max. opening size (width x height x length)	Wall: 1000 x 2000 mm Floor: 1000 x 600 mm	600 x 600 mm
Min. distance from cable tray to opening	0 mm	0 mm
Min. distance between cables tray	40 mm	40 mm
Re-installation possibility with CP 651 with CP 657 with CP 611A	(max. opening) 250 x 170 mm 200 x 100 mm Ø 160 mm	
Max. cable loading (as % of opening size)	60%	60%

### Installation instructions for CFS-M RG/CP 636



Clean opening, moisten surfaces

Mix CP 636 mortar (by adding mortar to water)

Put mortar into place

Optional: add CP 651 or CP 657 for future cable changes

Fasten installation plate in place (if required)

Re-installation: lay cables and close remaining opening

The above applications are not exhaustive. For further details please contact your local Hilti representative

## CP 637 Firestop mortar

### Product description

A fire resistant, gypsum based mortar with thermal insulating and acoustic properties for sealing medium to large sized openings where further penetrations may be required. Providing integrity of up to 4 hours.

### Areas of application:

- Permanent fire seal for cables and cable trays
- Permanent fire seal for combustible pipes
- Permanent fire seal for non combustible pipes  
Tested BS 476 Part 20 up to 4 hours in walls and floors

### Product features:

- Quick setting
- Low shrinkage
- Good adhesion to steel, concrete and masonry

### Base materials

Concrete, Porous Concrete, Masonry  
Suitable for spans up to 700mm per BS  
Suitable for unreinforced spans < 700mm per BS

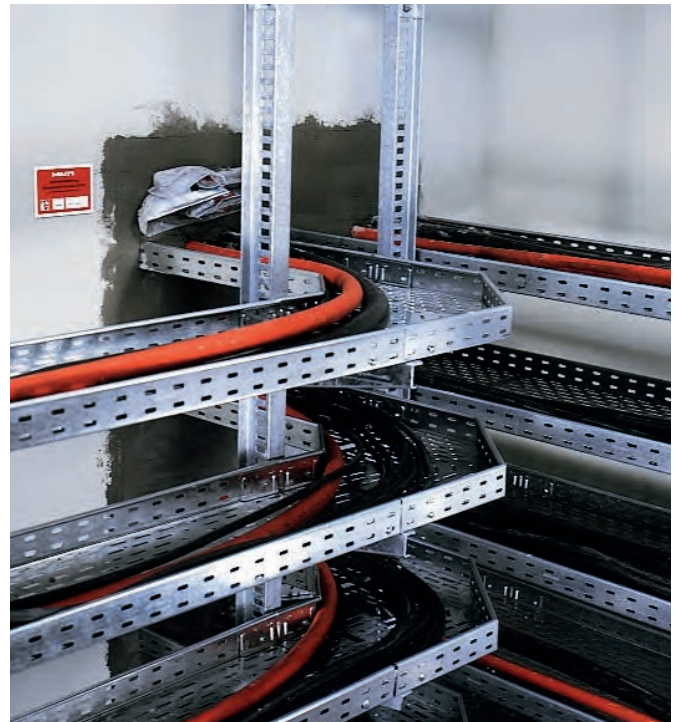

### Key applications & advantages

- Permanent fire seal for cables and cable trays
- Permanent fire seal for non-combustible pipes and combustible pipes (in combination with collars or wraps)
- Medium to large multiple penetrations in concrete and masonry in combination with other products
- Quick-setting - forms can be removed after as little as 2 hours
- Superior working properties - saves time

## Approvals Internationally tested and approved

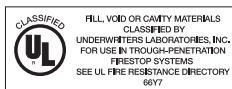

Other tests include : ASTM E 814 : ASTM E 84 : UL 1479

### Storage

- Observe expiry date on packaging.

**CP 637 Firestop mortar** \*ON DEMAND ITEM - Please ask your field engineer or account manager for more information (subject to change)



Ordering designation	Weight	Sales pack quantity	Item number
CP 637 FS	20 kg	1 pc	340785



## CP 637 Firestop mortar

### Technical data

Dry density	800 kg/m <sup>3</sup>
Color	Grey
Application Temperature Range	5°C - 40°C
Mix ratio (Mortar to Water by Weight)	3:1
Temperature resistance temperature range	-40°C - 400°C
Building material class	A1
Shelf life (@73°F/23°C and 50% relative humidity)	12 months
Wet density	1100 kg/m <sup>3</sup>
Compressive strength	2.9 N/mm <sup>2</sup>

### Consumption guide

100kg (6 x 20kg bags) per square meter for a seal 100mm thick.

### Application

1. Clean surfaces. Cables and cable supporting structures must be installed in compliance with local building and electrical standards.
2. Mix the mortar. Add mortar to water in a ratio of 3:1 (mortar to water). Stir the mixture thoroughly with a suitable utensil such as a Hilti mixing paddle. The mix ratio of CP638 determines the consistency (stiffness). Do not use any other binders or additives.
3. Apply the mortar. In slabs use form work and pour the mortar into the opening. In walls apply with a trowel and compact it. Make sure all gaps and openings are completely filled and closed.

### Installation instructions for CP 637



Clean opening, moisten surfaces

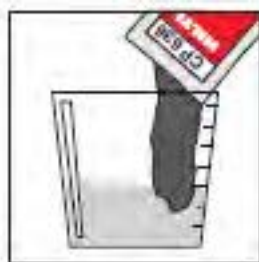

Mix CP 637 mortar (by adding mortar to water)



Put mortar into place



Fasten installation plate in place (if required)

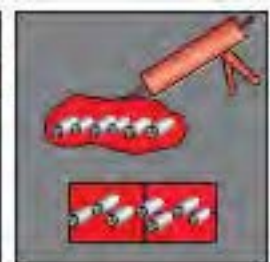

Re-installation: lay cables and close remaining opening

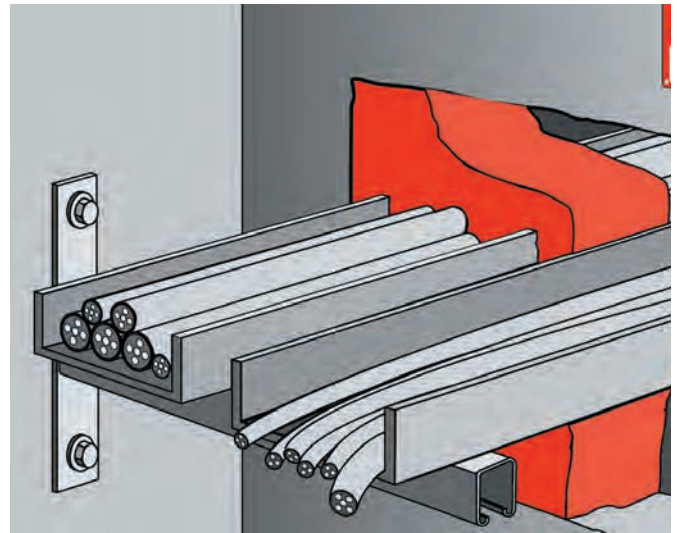

### Safety precautions

- Please refer to MSDS data sheet available as a download from the Technical Library on the Hilti web site at [www.hilti.co.za](http://www.hilti.co.za)
4. Changing cables: CFS-BL firestop cushion, CFS-BL firestop brick and CP611A intumescent mastic can be incorporated into the seal by installation of additional cables at a later date.
  5. For maintenance reasons, a penetration seal could be permanently marked with an installation plate. In such a case mark the installation plate and fasten it in a visible position next to the seal.
  6. Re-installation: if more cables are installed at a later date, lay cables and then close the remaining openings with CP611A.

## CP 638 HS FS Firestop mortar

### Product description

A fire resistant, gypsum based mortar with thermal insulating and acoustic properties for sealing medium to large sized openings where further penetrations may be required. Providing integrity of up to 4 hours.

### Areas of application:

- Permanent fire seal for cables and cable trays
  - Permanent fire seal for combustible pipes
  - Permanent fire seal for non combustible pipes
  - Permanent fire seal for fire dampers
- Tested BS 476 Part 20 up to 4 hours in walls and floors

### Product features:

- Quick setting
- Expands when set to provide smoke seal
- Good adhesion to steel, concrete and masonry

### Base materials

Concrete, Porous Concrete, Masonry  
Suitable for unreinforced openings < 1600mm per BS



### Key applications & advantages

- High yield.
- Rapid cure.
- Good substrate adhesion.
- Water resistant.

## Approvals Internationally tested and approved



Other tests include : ASTM E 814 : ASTM E 84 : UL 1479

### Storage

- Observe expiry date on packaging.

**CP 638 HS FS Firestop mortar** \*ON DEMAND ITEM - Please ask your field engineer or account manager for more information (subject to change)



Ordering designation	Weight	Sales pack quantity	Item number
CP 637 FS	20 kg	1 pc	360646

## CP 638 HS FS Firestop mortar

### Technical data

Dry density	1530 kg/m <sup>3</sup>
Color	Light grey
Application Temperature Range	5°C - 40°C
Mix ratio (Mortar to Water by Weight)	3:1
Temperature resistance temperature range	-20°C - 100°C
Building material class	A1
Shelf life (@73°F/23°C and 50% relative humidity)	12 months
Wet density	1820 kg/m <sup>3</sup>
Compressive strength	21 N/mm <sup>2</sup>

### Load bearing

CP638 is load bearing across large spans without reinforcement. Typically a 125mm thick CP638 seal with spans of up to 1.6m by any length are capable of supporting light foot traffic without any reinforcement. Certain openings may require reinforcing. Please contact Hilti for details

### Consumption guide

100kg per square meter for a seal 100mm thick.

### Application

1. Clean surfaces. Cables and cable supporting structures must be installed in compliance with local building and electrical standards.
2. Mix the mortar. Add mortar to water in a ratio of 3:1 (mortar to water). Stir the mixture thoroughly with a suitable utensil such as a Hilti mixing paddle. The mix ratio of CP638 determines the consistency (stiffness). Do not use any other binders or additives.
3. Apply the mortar. In slabs use form work and pour the mortar into the opening. In walls apply with a trowel and compact it. Make sure all gaps and openings are completely filled and closed.

### Installation instructions for CP 638



Clean opening, moisten surfaces



Mix CP 638 mortar (by adding mortar to water)



Put mortar into place



Fasten installation plate in place (if required)

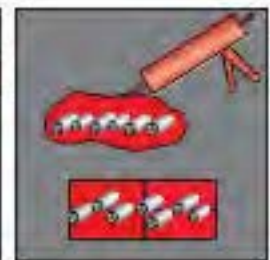

Re-installation: lay cables and close remaining opening

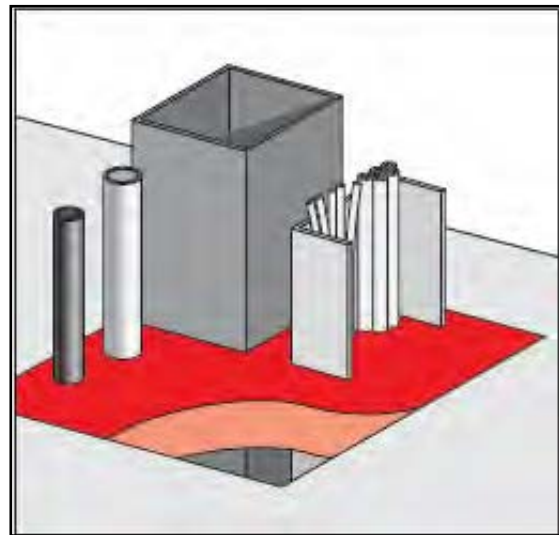

### Safety precautions

- Please refer to MSDS data sheet available as a download from the Technical Library on the Hilti web site at [www.hilti.co.za](http://www.hilti.co.za)

4. Changing cables: CFS-BL firestop cushion, CFS-BL firestop brick and CP611A intumescent mastic can be incorporated into the seal by installation of additional cables at a later date.
5. For maintenance reasons, a penetration seal could be permanently marked with an installation plate. In such a case mark the installation plate and fasten it in a visible position next to the seal.
6. Re-installation: if more cables are installed at a later date, lay cables and then close the remaining openings with CP611A.

The above applications are not exhaustive. For further details please contact your local Hilti representative

## CFS-C EL Firestop collar

### Product description

A ready to use firestop collar made of a galvanised steel housing and intumescent inserts for firestopping combustible pipes. Tested to BS476 Part 20.

### Areas of application:

- PVC pipes
- HDPE pipes
- PP pipes
- ABS pipes

### Product features:

- Adjustable mounting tabs
- Ready to use no tools required for installation
- Simple and rapid installation by hand

### Base materials

Concrete, Drywall, Masonry, Porous Concrete



### Key applications & advantages

- Plastic pipes with diameters from 32 - 170 mm
- Configurations tested include pipe elbows, inclined pipes, pipes with limited clearance to the wall
- Acoustic pipes tested with insulation and sound decoupling
- Zero distance required to CFS-B firestop bandage, CFS-C EL firestop endless collar and Conlit
- Suitable for use on shaft walls, coated board, drywall, aerated concrete, masonry and concrete

Ordering designation	Height	Sales pack quantity	Item number
CFS-C EL	17 mm	1 pc	304326

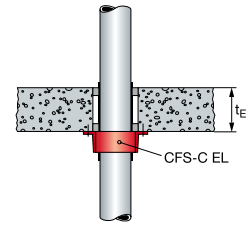
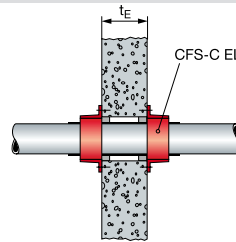
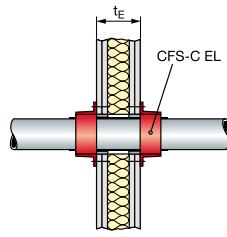
**General information**

Partition	Flexible wall	Rigid wall	Rigid floor
Base material thickness ( $t_E$ )	$\geq 100$ mm	$\geq 100$ mm	$\geq 150$ mm
Annular gap	0 - 15 mm	0 - 40 mm	
Fixing to wall	HTB-S, HHD-S	HUS-H, HUS-P	
Gap filler	CFS-S ACR*	CFS-S ACR* +Mineral wool backfilling for annular gap > 15 mm	
Penetration	Plastic pipes (PE, PP, PVC, ABS...)		

\*Use CFS-S ACR as gap filler, unless otherwise noted. See ETA for full details for the correct application.

**Main approved applications**

Excerpt of ETA document. Check the exact field of application for each pipe (type, diameter and pipe wall thickness) in the ETA 14/0085 document.

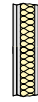

Application	Pipe material	Pipe $\varnothing$ mm	Flexible wall	Rigid wall	Rigid floor
<b>Waste water</b> 	PVC (EN 1452-1, EN 1329-1, EN 1453-1, EN 1566-1)	32 to 110	EI 120 U/U		
	PE (EN 1519-1, EN 12666-1, EN 2201-2) Geberit db20		EI 120 U/U		
	PP (EN 1451-1), DIN 8077/78		EI 120 U/C to EI 120 U/U	EI 90 U/U to EI 120 UU	
	Mineralised PP acoustic pipes*		EI 120 U/U		
<b>Letter shots</b> 	PVC-U (DIN 6660)		EI 90 U/U	EI 120 U/U	
<b>Industrial</b> 	PE (EN 15494, EN 12201-2, DIN 8074/75) Wavin W		EI 90 U/C to EI 120 U/U	EI 120 U/U	
<b>Various</b>	ABS (EN 1455-1, EN 15493) and SAN+PVC (EN 1565-1)		EI 60 U/U to EI 90 U/U	EI 120 U/U	

\*\*Non-regulated pipes : Coes PhoNoFire®, Coes blue power, Geberit Silent PP, Ke Kelit Phonex AS, Marely Silent, Maincor Mainpower, Ostendorf-Gruppe, Skolan db, Pipelife Master 3, Poloplast Polokal NG, Poloplast Polokal 3S, Raupiano Plus, Valsir Triplus, Wavin SiTech, Wavin AS.

**Other approved applications**
**Straight large pipes**

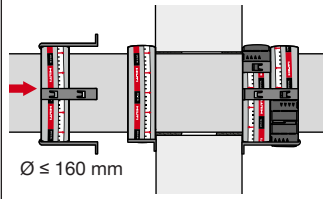
 For pipes  $125 \text{ mm} \leq \varnothing \leq 160 \text{ mm}$ 

[Watch instructional video](#)
[View ETA 14/0085 for details of approved pipes](#)
[Buy long hooks for 2nd Endless Collar \(#2075123\)](#)

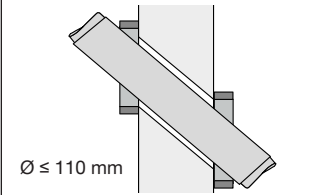
**Inclined pipes**

 For pipes  $\varnothing \leq 110 \text{ mm}$ 

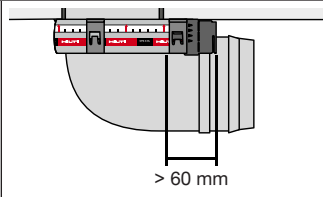
[Watch instructional video](#)
[View ETA 14/0085 for details of approved pipes](#)

**Elbow pipes**

 For pipes  $\varnothing \leq 110 \text{ mm}$ 

[Watch instructional video](#)
[View ETA 14/0085 for details of approved pipes](#)
[Buy CFS-FIL sealant \(#2052899\)](#)

**Pipe on wall / pipe in corner**

 For pipes  $\varnothing \leq 110 \text{ mm}$ 

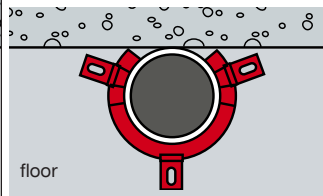
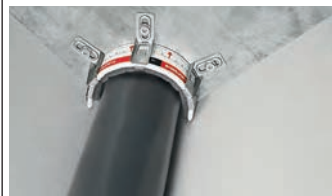
Pipes through floors, CFS-C EL to completely cover pipe perimeter.



[View ETA 14/0085 for details of approved pipes](#)
**Pipe junctions in floor (manifold)**

 For pipes  $\varnothing \leq 160 \text{ mm}$ 

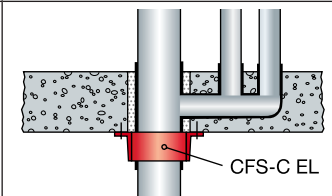
CFS-C EL only installed on main waste water pipe.

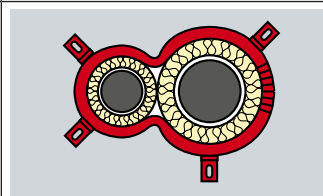
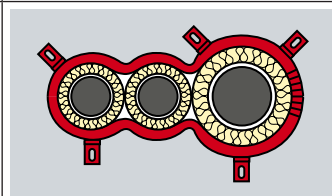

[View ETA 14/0085 for details of approved pipes](#)
**Multiple pipes in one collar**

 For pipes  $40 \text{ mm} \leq \varnothing \leq 90 \text{ mm}$ 

 Distance between hooks  $\leq 150 \text{ mm}$ .

[View ETA 14/0085 for details of approved pipes](#)
**Zero distance to CFS-C EL,**
**Conlit, CFS-B**

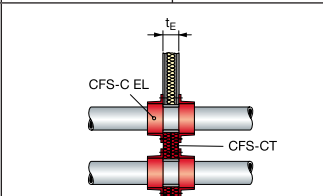
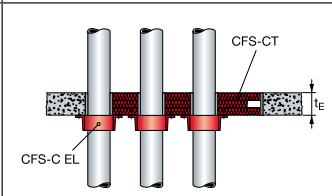
 For pipes  $\varnothing \leq 110 \text{ mm}$ 





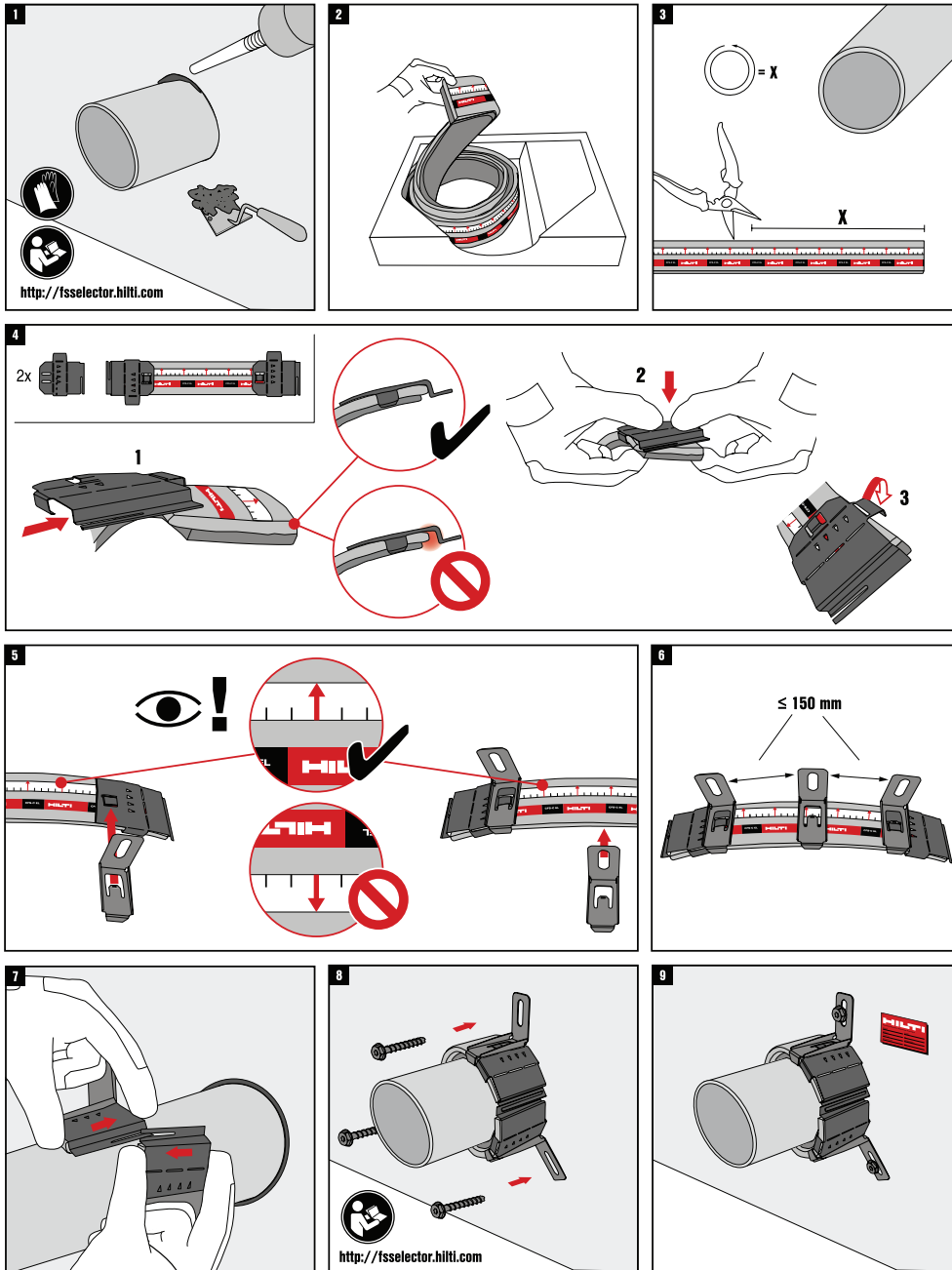

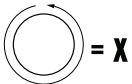

[View ETA 14/0085 for details of approved pipes and configurations](#)
**Coated boards**

 For pipes  $\varnothing \leq 100 \text{ mm}$ 

[View ETA 14/0085 for details of approved pipes through coated boards in floors and walls](#)

**General instruction for use**



**Recommended length and number of hooks (standard applications)**

 $\text{Ø} \leq 110 \text{ mm}$	 <b>2x</b>	 mm	 CFS C-EL mm	 4 mm CFS C-EL mm	 9 mm CFS C-EL mm	 13 mm CFS C-EL mm	 25 mm CFS C-EL mm
				16	130	130	160
		32	150	180	210	230	310
		40	180	200	230	260	340
		50	210	230	270		
	 <b>3x</b>	56	230	250	290		
		63	250	280	310		
		75	290	310	340		
		90	340	360	390		
		110	400	420	450		

## CFS-C/CP 643 N Firestop collar

### Product description

A ready to use firestop collar made of a galvanised steel housing and intumescent inserts for firestopping combustible pipes. Tested to BS476 Part 20.

### Areas of application:

- PVC pipes
- HDPE pipes
- PP pipes
- ABS pipes

### Product features:

- Adjustable mounting tabs
- Ready to use no tools required for installation
- Simple and rapid installation by hand

### Base materials

Concrete, Drywall, Masonry, Porous Concrete



### Key applications & advantages

- Plastic pipes with diameters from 32 - 170 mm
- Pipes with acoustic insulation
- Walls from 100 mm thick and floors from 150 mm thick
- Ready-to-use product
- Latch mechanism for quick and easy closure

### Approvals Internationally tested and approved

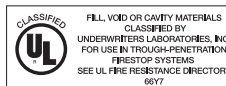

# EN 1366-3

**Other tests include :** ASTM E 814 : ASTM C 920 : ASTM E 1399 : ASTM E 90-97 : ASTM E 84-96 : UL 2079 : UL 1479 : ISO 11600

### Recommendations for use

- Fit the jacket around the pipe, lock the closure with firm pressure until it latches.
- Fit the fastening hooks on the firestop jacket to suit the available space.
- Secure the firestop jacket using approved Hilti approved anchors. (See examples in page 66)

The following dimensions must be observed when fitting the CFS-C/CP 643 N firestop collar per BS:

	Wall	Floor
Material	cellular concrete masonry solid concrete	cellular concrete
Min. thickness of building component for pipes	100 mm	150 mm
Min. pipe diameter	32 mm	32 mm
Max. pipe diameter	170 mm	170 mm
CP 643N	two mounted, one on each side	one mounted on underside

\* Can be installed in 50 mm thick CP670 coated board system.

### CP 643 N Firestop collar \*ON DEMAND ITEM - Please ask your field engineer or account manager for more information (subject to change)

Ordering designation	Outside diameter	Sales pack quantity	Item number
CFS-C/CP 643 N-63/2" N	82 mm	1 pc	304326
CFS-C/CP 643 N-75/2.5" N	102 mm	1 pc	304327
CFS-C/CP 643 N-110/4" N	146 mm	1 pc	304329
CFS-C/CP 643 N-125/5" N	166 mm	1 pc	304330
CFS-C/CP 643 N-160/6" N	236 mm	1 pc	304331





## CFS-C/CP 643 N Firestop collar

### Technical data

Expansion temperature (approx.)	250 °C
Expansion ratio (unrestricted, up to)	1:17
Application temperature range	-5 - 50 °C
Building material class (according to DIN 4102)	B2
Base materials	Concrete, Drywall, Masonry
LEED VOC	7.6 g/l
Colour	Metallic grey

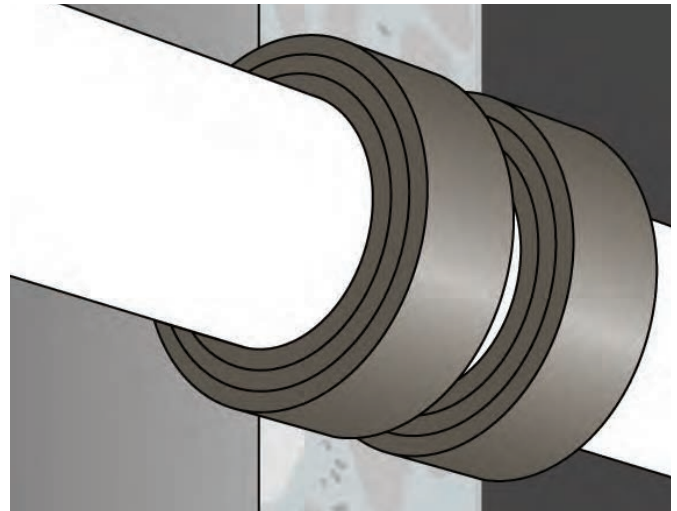

### Acoustic insulation – installation tips

- Close the remaining opening (max. 20 mm wide annular space) with non-flammable mineral wool with a melting temperature >1000°C. For a neat finish, apply CP 611A / FSOne intumescent firestop mastic about 10mm thick on both sides.
- Position the firestop collar to ensure that it and the pipe are not touching at any point.

### Penetration

- Drill through the wall/floor using Hilti DCM diamond drilling equipment and a core bit of suitable size.
- Install the plastic pipe

### Fit the CFS-C/CP 643 N firestop collar

#### 1. Seal the opening

Large gaps must be closed with mortar. Alternatively, they can be closed with CP 611A. / FS - One.

The approved methods vary and are given in the test certificates and approvals.

#### 2. Clean the plastic pipes

Expansion of the intumescent material during a fire closes the plastic pipe. Very dirty pipes with, for example, remains of mortar, may lead to a delay in this closing action. Badly soiled plastic pipes should, therefore, be cleaned in the area where the CFS-C/CP 643 N firestop collar is to be installed.

#### 3. Seal against smoke and gases

Gaps between the plastic pipe and the opening must be sealed on one side of the wall with sealant CP 611A / FS One to seal against smoke and gases passing through the gaps during the first minutes of fire. The intumescent inlay of CFS-C/CP 643 N will close the opening, when activated by heat and fire.

### Safety precautions

- Please refer to MSDS data sheet available as a download from the Technical Library on the Hilti web site at [www.hilti.co.za](http://www.hilti.co.za)

#### 4. Attach fastening hooks (supplied in the box)

The fastening hooks can be attached to various points on the metal housing. This allows the fastening points to be made to suit the space available in each case. The hooks must be positioned as symmetrically as possible. The required number of fastening hooks is indicated on the packaging and in the table on the previous page.

#### 5. Cast-in mounting

- Ensure the penetration is large enough to accommodate the outside diameter of the CFS-C/CP 643 N collar.
- Slide the CFS-C/CP 643 N collar into the opening.
- For ceilings, CFS-C/CP 643 N must be flush with the soffit
- For walls, Insert one collar from each side,
- Backfill around the installed collar with mortar.

### Installation instructions for CFS-C/CP 643 N Use CP611A for smoke and acoustic seal

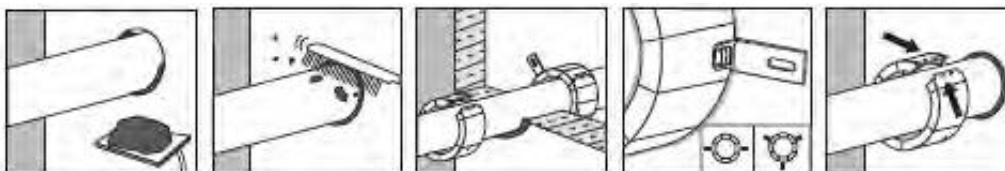

Close remaining gap to ensure smoke and gas tight seal

Clean plastic pipe

Seal against smoke and gases

Attach fastening hooks

Close collar

## CFS-C P/CP 644

### Firestop collar

Sealing of flammable pipes for fire resistant up to 4 hours.

#### Product description

A ready to use firestop collar designed for firestop openings with plastic pipes up to 250mm with pipe wall thickness from 1.8mm - 16.2mm in concrete, masonry, wood floor assemblies and gypsum walls. Tested to BS476 Part 20.

#### Areas of application:

- PVC, PVCC, PVC HI pipes
- HDPE pipes
- PP pipes
- ABS pipes
- B1/B2 pipes

#### Product features:

- Low profile for tight installations
- Ready to use no preparatory work required
- No minimum gap required between collars
- Tested in high and low wall thickness pipes
- Simple and rapid installation by hand

#### Base materials

Concrete, Masonry, Drywall, Porous Concrete, Wood floor assemblies

#### Approvals Internationally tested and approved

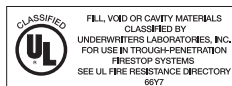

## EN 1366-3

Other tests include : ASTM E 814 : UL 1479 : DIN 4102 Part 11

#### Recommendations for use

- Fit the jacket around the pipe, lock the closure with firm pressure until it latches.
- Fit the fastening hooks on the firestop jacket to suit the available space.
- Secure the firestop jacket using approved Hilti approved anchors. (See examples in page 66)

### CFS-C P/CP 644 Firestop collar **\*ON DEMAND ITEM - Please ask your field engineer or account manager for more information (subject to change)**

Ordering designation	Outside diameter	Sales pack quantity	Item number
CFS-CP/CP 644-50/1.5"	67 mm	1 pc	304332
CFS-CP/CP-63/2"	82 mm	1 pc	304333
CFS-CP/CP-75/2.5"	102 mm	1 pc	304334
CFS-CP/CP-90/3"	117 mm	1 pc	304335
CFS-CP/CP-110/4"	146 mm	1 pc	304336
CFS-CP/CP-180/7"	228 mm	1 pc	304339
CFS-CP/CP-160/6"	236 mm	1 pc	304338
CFS-CP/CP-200/8"	257 mm	1 pc	304340
CFS-CP/CP-225/9"	289 mm	1 pc	304342
CFS-CP/CP-250/10"	319 mm	1 pc	304343



#### Key applications & advantages

- PVC, HDPE, PP and ABS pipes
- Sealing flammable pipes from 32 mm to 250 mm in diameter in penetrations through fire compartment walls and floors
- Pipes with acoustic insulation
- Ready-to-use firestop collar with a galvanized steel housing
- Latch mechanism for quick and easy closure

The following dimensions must be observed when fitting the CP 644 firestop collar per BS:

	Wall	Floor
Material	cellular concrete masonry solid concrete	cellular concrete
Min. thickness of building component for pipes	100 mm	150 mm
Min. pipe diameter	32 mm	32 mm
Max. pipe diameter	250 mm	250 mm
CP 644	two mounted, one on each side	one mounted on underside

\* Can be installed in 50 mm thick CP670 coated board system.



## CFS-C P/CP 644 Firestop collar

### Technical data

Expansion temperature (approx.)	210 °C
Expansion ratio (unrestricted, up to)	1:17
Application temperature range	-5 - 50 °C
Building material class (according to DIN 4102)	B2
Base materials	Concrete, Drywall, Masonry
LEED VOC	7.6 g/l
Colour	Metallic grey

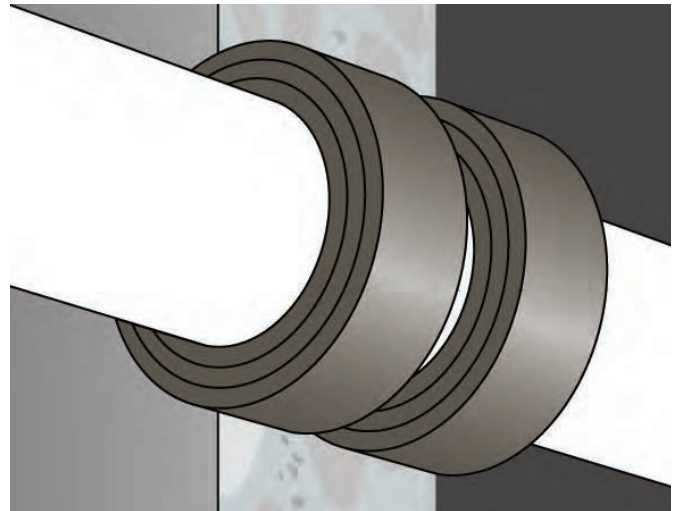

### Acoustic insulation – installation tips

- Close the remaining opening (max. 20 mm wide annular space) with non-flammable mineral wool with a melting temperature >1000°C. For a neat finish, apply CP 611A / FSOne intumescent firestop mastic about 10mmthick on both sides.
- Position the firestop collar to ensure that it and the pipe are not touching at any point.

### Penetration

- Drill through the wall/floor using Hilti DCM diamond drilling equipment and a core bit of suitable size.
- Install the plastic pipe

### Fit the CFS-C P/CP 644 firestop collar

#### 1. Seal the opening

Large gaps must be closed with mortar. Alternatively, they can be closed with CP 611A. / FS - One.

The approved methods vary and are given in the test certificates and approvals.

#### 2. Clean the plastic pipes

Expansion of the intumescent material during a fire closes the plastic pipe. Very dirty pipes with, for example, remains of mortar, may lead to a delay in this closing action. Badly soiled plastic pipes should, therefore, be cleaned in the area where the CFS-C P/CP 644 firestop collar is to be installed.

#### 3. Seal against smoke and gases

Gaps between the plastic pipe and the opening must be sealed on one side of the wall with sealant CP 611A / FS One to seal against smoke and gases passing through the gaps during the first minutes of fire. The intumescent inlay of CFS-C P/CP 644 will close the opening, when activated by heat and fire.

### Safety precautions

- Please refer to MSDS data sheet available as a download from the Technical Library on the Hilti web site at [www.hilti.co.za](http://www.hilti.co.za)

#### 4. Attach fastening hooks (supplied in the box)

The fastening hooks can be attached to various points on the metal housing. This allows the fastening points to be made to suit the space available in each case. The hooks must be positioned as symmetrically as possible. The required number of fastening hooks is indicated on the packaging and in the table on the previous page.

#### 5. Cast-in mounting

- Ensure the penetration is large enough to accommodate the outside diameter of the CP 643N collar.
- Slide the CFS-C P/CP 644 collar into the opening.
- For ceilings, CFS-C P/CP 644 must be flush with the soffit
- For walls, Insert one collar from each side,
- Backfill around the installed collar with mortar.

### Installation instructions for CFS-C P/CP 644 Use CP611A for smoke and acoustic seal

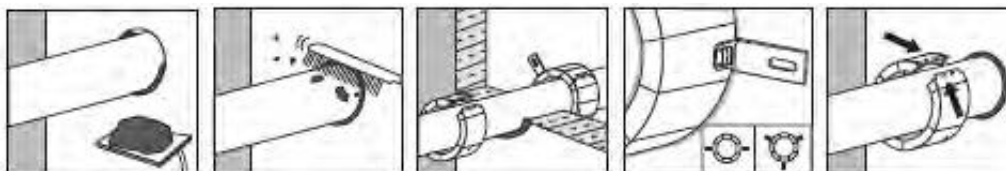

Close remaining gap to ensure smoke and gas tight seal

Clean plastic pipe

Seal against smoke and gases

Attach fastening hooks

Close collar

## CFS-CID/CP 680 Firestop Cast-in Device

### Product description

The CFS-CID/CP 680 cast-in device consists of a polypropylene body containing an insert of intumescent material. An elastic sealing membrane allows for flexibility to use with differing pipe materials with different diameters. Providing fire rated protection of up to 3 hours.

### Areas of application:

- Sealing pipes from 1.5" (32 mm) up to 6" (170) mm in penetrations through fire rated floor compartments.
- Suitable for the following Pipe materials.
  - Plastic pipes: PVC, CPVC, ABS, FRPP, ENT/PEX
  - Metal pipes: steel, copper; EMT, conduit
  - Insulated steel and copper metal pipes

### Product features:

- Ready-to-use device
- One step installation resulting in greatly reduced installation time
- Tested in various concrete floor thickness from 2.5"/63 mm
- For use with a variety of plastic and metal pipes and electrical conduits from 1.5" (32 mm) up to 6" (170 mm)
- Flexible in allowing a variety of pipe diameters and materials
- Quick and simple installation
- Water and smoke tight
- Excellent good sound insulation
- Allows for pipe movement and vibrations during and after installation.

### Base materials

Concrete floors from 2.5" (63 mm) thickness over metal-decking

### Approvals Internationally tested and approved

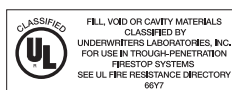

**Other tests include :** ASTM E 814 : UL 1479 : DIN 4102 Part 11

### Maintenance

- CFS-CID/CP 680 allows replacement of pipes. When performing this operation please adhere to the following steps.
  1. When removing a pipe, and a new pipe is not immediately being passed through the device, tape shut the top of the CFS-CID/CP 680 cast-in device to prevent any passage of smoke in case of fire.



### Key applications & advantages

- PVC, HDPE, PP and ABS pipes
- Sealing flammable pipes from 32 mm to 250 mm in diameter in penetrations through fire compartment walls and floors
- Pipes with acoustic insulation
- Ready-to-use firestop collar with a galvanized steel housing
- Latch mechanism for quick and easy closure

2. When passing through a new pipe,
  - a) Ensure the external pipe diameter fits the CFS-CID/CP 680 castin device. Permitted dimensions are indicated on the underside of the flange of the device.
  - b) Ensure that the pipe type passing through the device is approved.
  - c) Once the installation is finished, check the water tightness of the system.
  - d) In case of leakage, fill the remaining gap between the pipe and the device with a standard PU foam, mortar or elastomeric sealant.

### Storage

- Store only in the original packaging at temperatures 5°C to 25°C.
- Observe expiration date on packaging.

**\*ON DEMAND ITEM - Please ask your field engineer or account manager for more information (subject to change)**

## CFS-CID/CP 680 Firestop Cast-in Device

### Technical data

Color	Red
Pipe diameter - range	32 mm - 168mm
Fire rating	3 h
Intumescent	Yes

### Use with insulated metal pipes

- Close the remaining opening (max. 20 mm wide annular space) with non-flammable mineral wool with a melting temperature >1000°C. For a neat finish, apply CP 611A / FSOne intumescent firestop mastic about 10mm thick on both sides.
- Position the firestop collar to ensure that it and the pipe are not touching at any point.

### Installation instructions for CFS-CID/CP 680

Before handling, read the product and material safety data sheet for detailed usage and health information.

#### 1. Fix the CFS-CID/CP 680 cast-in firestop device

Use the correct size CP 680 cast-in firestop device and nail it in place correctly on the form work.

Before pouring the concrete, secure the top cap in place, thereby preventing the flow of concrete into the cast-in device.

#### 2. Pour the concrete slab to the required thickness.

#### 3. Remove the form work.

CFS-CID/CP 680 has been designed to ensure the nails used for fixing are removed with the form work.

#### 4. Clean the pipe.

The flexible sealing membrane, ensures water tightness of the device once the pipe has been passed through. Very dirty pipes with remains of mortar for example, may lead to a loss of tight seal by damaging this membrane. Very dirty pipes can also disturb expansion of the intumescent material and lead to delays in the closing action during fire. Badly soiled pipes should, therefore, be cleaned.

#### 5. Install the pipe

Pipes can be installed from the top or from the bottom. Remove the plastic protective caps and pass through the pipe breaking the white membrane.

If insulation is required pass the pipe through first followed by the insulation.

Installation is now finished and firestop functional.

#### Installation in concrete floor:



### Installation option:

If it is necessary to cut the CFS-CID/CP 680 cast-in firestop device to slab thickness before installation or when riser clamps are used, follow the instructions.

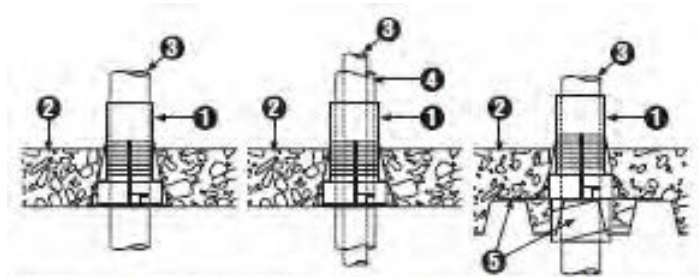
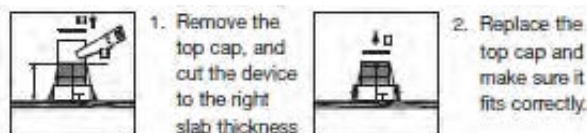

ⓐ - Cast-in device	CP 680 - 75/2.5"	CP 680 - 110/4"	CP 680 - 160/6"
ⓑ - Concrete Floor	Min. 2.5" (63 mm)		
ⓐ - Pipes	Min.a: 1.5" (32 mm) Max.a: 2.5" (75 mm)	Min.a: 3" (80 mm) Max.a: 4" (110 mm)	Min.a: 5" (125 mm) Max.a: 6" (170 mm)
■ Plastic pipes	PVC, CPVC, ABS & FRPP		
■ Metal pipes	Steel, Copper, Cast-iron, Conduit		
■ Electrical conduits	EMT, ENT/PEX		
ⓐ - Insulation	Glass fiber, AB/PVC		
ⓑ - Metal deck adaptor	Metal-deck adaptor 75/2.5"	Metal-deck adaptor 110/4"	Metal-deck adaptor 160/6"

### Dimensions of the device

Designation	Outside diameter of the flange	Total height of the device	Number of fixing points
CP 680-75/2.5"	8.4" (182 mm)	10" (250 mm)	4
CP 680-110/4"	8.5" (215 mm)	10" (250 mm)	4
CP 680-160/6"	11.1" (282 mm)	10" (250 mm)	5

### Dimensions of the metal deck adaptor

Designation	Height of the extension	Maximum dimension of the metal plate when fixed to the device
CP 680 Metal-deck adaptor 75/2.5"	Min. 3.7" (93 mm)	12" x 7" (325 mm x 180 mm)
CP 680 Metal-deck adaptor 110/4"	Min. 3.9" (100 mm)	14" x 8" (375 mm x 215 mm)
CP 680 Metal-deck adaptor 160/6"	Min. 4" (102 mm)	19" x 11" (485 mm x 282 mm)

### Installation in concrete floor over metal decking:

For concrete floor over metal decking applications, a special CFS-CID/CP 680-Metal deck Adaptor is required.

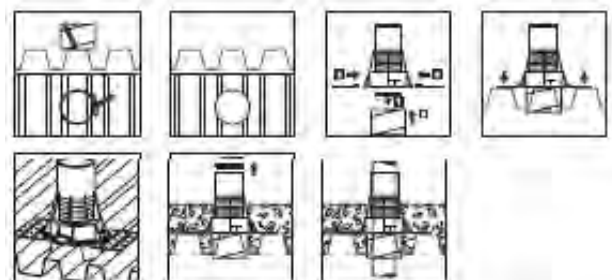

#### 1. Create the opening in the metal-deck

Use the correct size CFS-CID/CP 680 Metal Deck Adaptor with the installed cast-in device.

Size the hole with the cardboard extension, and cut the metal deck.

#### 2. Assemble the metal-deck Adaptor

Remove the underside plastic protective cap. Fix the cardboard extension and the two metal plates on the CFS-CID/CP 680 cast-in firestop device.

#### 3. Fix the CFS-CID/CP 680 Cast-In firestop device

Position the CFS-CID/CP 680 at the right place ensuring that the cardboard extension has been well positioned in the hole. Screw the two metal plates on the metal deck with the device using Hilti S-SMD-Z. Before pouring the concrete, make sure the top cap is in place thereby preventing the flow of concrete into the cast-in device.

#### 4. Pour the concrete slab to the required thickness

The above applications are not exhaustive. For further details please contact your local Hilti representative

## CFS-W SG/CP 648-S Firestop wrap strip

### Product description

A new innovative firestop wrap for sealing flammable pipes for fire resistance for up to 4 hours.

### Areas of application:

- Sealing flammable plastic pipes from 50-160mm per BS
- Pipes include: UPVC, ABS, PP, PE act.

### Product features:

- Special elastic material for good pliability
- Halogen and plasticizer free
- Water resistant
- Minimum thickness for smallest annular space required
- High performance fire expansion rate (40 : 1)

### Base materials

Concrete, Masonry, Porous concrete, Drywall



### Key applications & advantages

- Very fast installation
- No tools /drilling required
- Ready to use (precut)
- Extremely thin wrap thickness
- Simply insert wrap strip into annular space
- Minimum space required - ideal for limited penetration accessibility (ideal for bent pipes etc.)
- Easy to fasten with integrated adhesive closing tape

### Approvals Internationally tested an

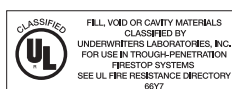

# EN 1366-3

Other tests include : UL 1479, ASTM E 814, ASTM E84: DIN 4102 Part 11

### Recommendations for use:

- Wall - two wraps in each side.
- Floor - one wrap on the underside.

### Storage

- Store only in the original packaging at temperatures 5°C to 25°C.
- Observe expiration date on packaging.

**\*ON DEMAND ITEM - Please ask your field engineer or account manager for more information (subject to change)**

## CFS-W SG/CP 648-S Firestop wrap strip

### Technical data

Density	1.35 g/cm <sup>3</sup>
Color	Black with foil backing
Expansion temperature	> 160 °C
Temperature resistance temperature range	-20°C - 100°C
Building material class	B2

### CFS-W SG/CP 648-S sizes

	For pipe diameter			Product dimensions			Recommended drill
	(mm)	(mm)	(mm)	Length (mm)	Thickness (mm)	Width (mm)	
CP 648-S	50/	1.5"	50	169	4.5	45	67"
CP 648-S	63/	2"	63	210	4.5	45	77"
CP 648-S	75/	2.5"	75	249	4.5	45	92"
CP 648-S	90/	3"	90	311	9	45	112"
CP 648-S	110/	4"	110	370	9	45	132"
CP 648-S	125/	5"	125	421	9	45	152"
CP 648-S	160/	6"	160	543	13.5	45	202"

\*or bigger

### Penetration

- Drill through the wall/floor using Hilti diamond drilling equipment and a core bit of suitable size
- Install the plastic pipe

### Installation

#### 1. Clean the plastic pipe

Expansion of the intumescent material during a fire closes the plastic pipe. Very dirty pipes with, for example, remains of mortar, may lead to a delay in this closing action. Badly soiled plastic pipes should, therefore, be cleaned in the area where the CFS-W SG/CP 648-S is to be installed.

#### 2. Install Wrap

First check the annular space. Use the CFS-W SG/CP 648-S strip corresponding to the diameter of the pipe to be installed. Wrap the CFS-W SG/CP 648-S around the pipe and fasten it tightly using the integrated adhesive strip. Push the CFS-W SG/CP 648-S wrap strip into the annular space until it is flush to the wall surface.

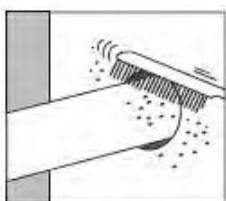

1. Clean the plastic pipe.

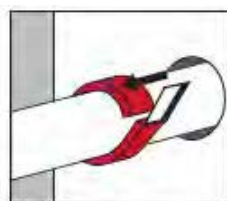

2. Wind the CP 648-S around the pipe and fasten it tightly with the adhesive strip.

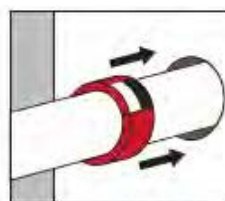

3. Push CP 648-S strip along the pipe into hole space, making sure CP 648-S is flush to the wall.

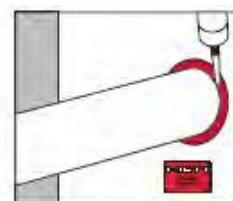

4. Close remaining gap to ensure smoke and gas tight seal. Fasten installation plate if required.

### Dimensions

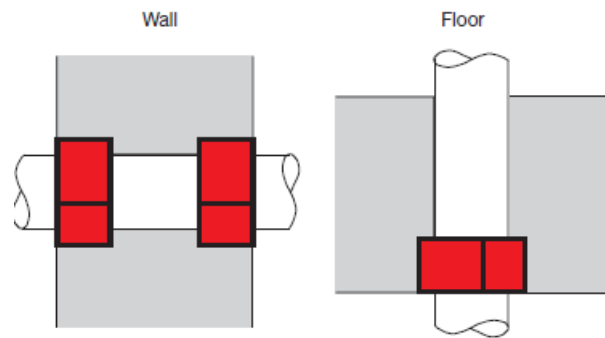

	Wall	Floor
Pipe diameter	Cellular concrete, Drywall concrete, masonry	Cellular concrete, concrete, masonry
50 - 110 mm	100 100	150
125-160mm	— 100/150*	150
CP648-S	One Wrap per side	One Wrap on underside

\*Exact dimensions depending on national approvals

### 3. Seal against smoke and gas

Seal the remaining gap with Firestop sealant (e.g. CP606). Larger annular spaces should be sealed with mortar (e.g. CP636, CP 620). In drywall sealing of the remaining gap also possible with gypsum.

### Notice about approvals

- CFS-W SG/CP 648-S is internationally tested and approved.
- When making a pipe seal using Hilti CFS-W SG/CP 648-S, national approvals must be observed in principle. Please refer to these for restrictions regarding opening size, type and wall /floor thickness, maximum pipe diameter etc.
- For maintenance reasons, a penetration seal can be marked permanently using an installation plate.

### Safety precautions

- Please refer to MSDS data sheet available as a download from the Technical Library on the Hilti web site at [www.hilti.co.za](http://www.hilti.co.za)

## CFS-W EL/CP 648-E Endless wrap strip

### Product description

An innovative and highly flexible endless wrap, for sealing flammable plastic pipes, suitable for heavy users. Tested to BS476 Part 20 for fire resistance of up to 4 hours.

### Areas of application:

- Sealing flammable plastic pipes from 50-160mm per BS
- Pipes include: UPVC, ABS, PP, PE act.

### Product features:

- 10 metre roll suitable for many applications
- No material waste as cut ends can be used
- Special elastic material for good pliability
- Halogen and plasticizer free
- Water resistant
- Minimum thickness for smallest annular space required
- High performance fire expansion rate (40 : 1)

### Base materials

Concrete, Masonry, Porous concrete, Drywall  
Wall from 100mm thick  
Floors from 150mm thick



### Key applications & advantages

- An intumescent, flexible firestop wrap strip for combustible pipe penetrations
- Can be used with orthogonal pipes and pipes at 45°
- Concrete, masonry floor and gypsum wall assemblies
- Quick and easy closure without need for tools
- Easy to cut
- Minimum space required - ideal for limited penetration accessibility (ideal for bent pipes etc.)
- Easy to fasten with integrated adhesive closing tape

### Approvals Internationally tested and

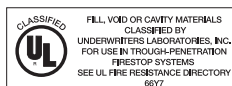

## EN 1366-3

Other tests include : UL 1479, ASTM E 814, ASTM E84/DIN 4102 Part 11

### Recommendations for use:

- Wall - two wraps in each side.
- Floor - one wrap on the underside.

### Storage

- Store only in the original packaging in a location protected from moisture at a temperature of 5°C to 25°C.

## CFS-W EL/CP 648-E Endless wrap strip



Ordering designation	Sales pack quantity	Item number
CFS-W EL/CP 648-E-W45/1.8"	1 pc	304310



## CFS-W EL/CP 648-E Endless wrap strip

### Technical data

Color	Black with foil backing
Density	1.35 g/cm <sup>3</sup>
Intumescent	Yes
Expansion temperature	> 160 °C
Building material class	B2

### Application table

Pipe dimension (mm)	No. Layers	Wrap length (cm)	Applications with a 10m roll (No.)	Recommended drill hole X (mm)
50	1	17	58	67*
63	1	21	47	77*
75	1	25	40	92*
90	2	64	15	112*
110	2	75.5	13	132*
125	2	85.5	11	152*
160	3	166	6	202*

\*or bigger

### Penetration

- Drill through the wall/floor using Hilti diamond drilling equipment and a core bit of suitable size
- Install the plastic pipe

### Installation

#### 1. Clean the plastic pipe

Expansion of the intumescent material during a fire closes the plastic pipe. Very dirty pipes with, for example, remains of mortar, may lead to a delay in this closing action. Badly soiled plastic pipes should, therefore, be cleaned in the area where the CFS-W EL/CP 648-E is to be installed.

#### 2. Cut Wrap to required length

First check the annular space, then cut CFS-W EL/CP 648-E to length according to the outer diameter of the pipe to be installed, taking the required number of layers into consideration. See the measurement table printed in this data sheet or on the product packaging for guidance.

#### 3. Install Wrap

Wrap the CP648-E around the pipe and secure it with a short strip of adhesive tape. Push CFS-W EL/CP 648-E wrap strip into the annular space until flush with the wall.

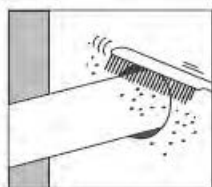

1. Clean the plastic pipe.

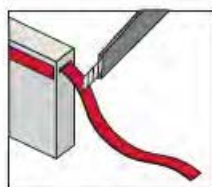

2. Cut CP 648-E to the correct length (see measurement table on product packaging for help).

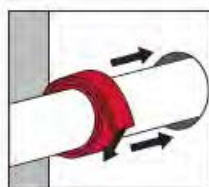

3. Wrap the CP 648-E around the pipe, fasten it with adhesive tape and push it into the annular space.

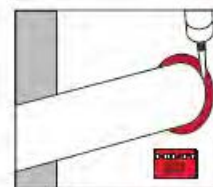

4. Close remaining gap to ensure smoke and gas tight seal. Fasten installation plate if required.

### Dimensions

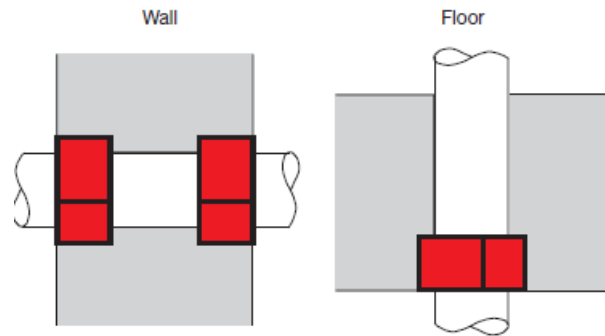

	Wall	Floor
Pipe diameter	Cellular concrete, Drywall concrete, masonry	Cellular concrete, concrete, masonry
50 -110 mm	100 100	150
125-160mm	— 100/150*	150
CP648-E	One Wrap strip on each side (with required number of layers)	One Wrap strip on underside (with required number of layers)

\*Exact dimensions depending on national approvals

### 4. Seal against smoke and gas

Seal the remaining gap with Firestop sealant (e.g. CP606). Larger annular spaces should be sealed with mortar (e.g. CP636). In drywall, sealing of the remaining gap also possible with gypsum.

### Notice about approvals

- CP648-E is internationally tested and approved.
- When making a pipe seal using Hilti CFS-W EL/CP 648-E, national approvals must be observed in principle. Please refer to these for restrictions regarding opening size, type and wall /floor thickness, maximum pipe diameter etc.
- For maintenance reasons, a penetration seal can be marked permanently using an installation plate.

### Safety precautions

- Please refer to MSDS data sheet available as a download from the Technical Library on the Hilti web site at [www.hilti.co.za](http://www.hilti.co.za)

## CFS-PL Firestop plug

### Product description

A ready to use intumescent flexible plug composed of a two component polyurethane foam. Suitable for sealing circular penetrations and providing fire ratings tested up to 3 hours.

### Areas of application:

- Sealing of 50mm - 200mm circular penetrations
- Sealing bunched or single cables through wall and floors
- Suitable for applications in dust free environments
- Suitable for both temporary and permanent applications

### Product features:

- Free from dust and fibre
- Halogen and solvent free
- Operational immediately after installation
- Can be painted

### Base materials

Concrete, Porous concrete, Masonry, Drywall



### Key applications & advantages

- Excellent for re-penetration with new cables
- Economical in use owing to short installation time
- Easy installation as no special tool is required
- Functional after installation
- Dust, fibre, halogen and solvent free

## Approvals Internationally tested and approved

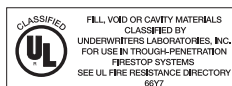

### Recommendations for use:

- The firestop system consists of the CFS-PL firestop plug and CP 611A firestop filler.
- First cut plugs to shape for cable bundles to pass through them.
- Insert CFS-PL firestop plugs into both sides of the penetration.
- Fill and close gaps around and between cables with CP 611A firestop filler.
- Diamond core bits are recommended for drilling penetrations.

**\*ON DEMAND ITEM - Please ask your field engineer or account manager for more information (subject to change)**

## CFS-PL Firestop Plug

### Technical data

Expansion temperature (approx.)	210 °C
Expansion ratio (unrestricted, up to)	1:19
Application temperature range	-5 - 50 °C
Building material class (according to DIN 4102)	B2
Base materials	Concrete, Drywall, Masonry
LEED VOC	3.1 g/l
Colour	Grey, printed foil
Dimensions (LxWxH)	10000 x 45 x 5 mm
Height	5 mm

### Application table

Firestop plug	Diameters of Hilti diamond bits	
	max. hole dia.	min. hole dia.
CP 658	62 mm	42 mm
CP 658	77 mm	67 mm
CP 658	107 mm	92 mm
CP 658	132 mm	112 mm
CP 658	156 mm	152 mm
CP 658	200 mm	192 mm

### Penetration

- Drill the hole with Hilti diamond drilling equipment and a suitable core bit.
- Clean the opening.
- Cables and cable supporting structures must be installed in compliance with local building and electrical standards.

### Installation

**a) If cables are not laid** (temporary firestop), insert CFS-PL firestop plugs from both sides and compress them. Fill gaps and spaces of irregular hole surfaces with CP 611A/FS-One firestop filler.

### Dimensions

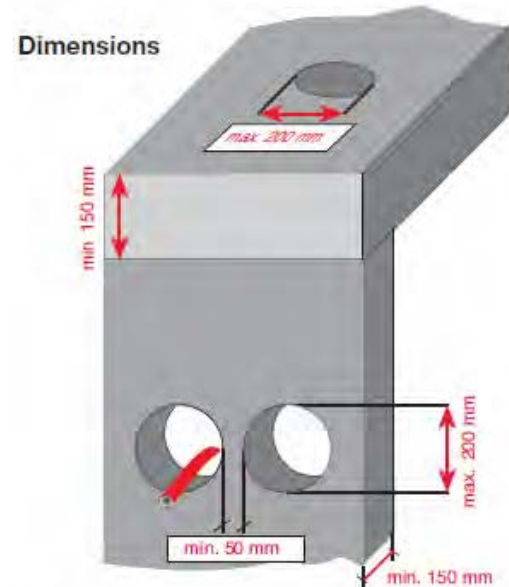

The following dimensions must be observed when making the seal per BS:

Floor	Wall	
Min. thickness of building component	150 mm*	150 mm*
Max. opening size	200 mm	200 mm
Min. distance between cables/cable run and opening surface	0 mm	0 mm
Min. distance to next opening	50 mm	50 mm
Max. cable loading (as % of opening size)	60 %	60 %

**b) If cables are laid** (permanent firestop), cut CFS-PL firestop plugs to suit the cable circumference using a knife. Insert plugs from both sides and compress them. Fill cable spaces and gaps with CP 611A/FS-One firestop mastic corresponding to the thickness of the CP 658 firestop plug.

### Notes

- CP 611A/FS-One can be smoothed using a paint brush and water before a skin forms.
- It is not necessary for the firestop plug to be bonded to the side of the hole.

### c) Re-installing cables

If single cables are subsequently installed, a hole can be drilled through the plug and a cable passed through.

#### Installation instructions for CP 658

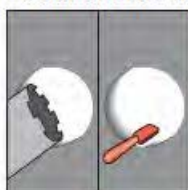

Core drill and clean hole

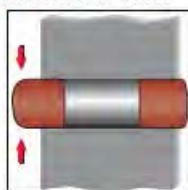

Without cables, fit plugs into hole



With cables, cut plugs to fit around cables

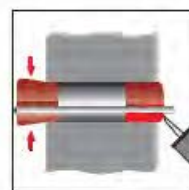

Fit plug and fill gaps with CP 611A/FS-One



Fasten installation plate in place (if required)

## CFS-BL Firestop block

### Product description

Ready-to-use, intumescent flexible block designed to seal medium to large size openings

### Areas of application:

- Sealing single or multiple penetrations in small to large openings
- Temporary or permanent sealing of cables and cable tray penetrations
- Temporary or permanent sealing of insulated and non-insulated metallic pipes and combustible pipe penetrations

### Product features:

- Integrated “Grid-Tech” increases Annular Space up to 12”
- Suitable for re-penetration or new penetrations
- Economical to use with short installation times
- Easy installation — no special tools required
- Ideal for use in floors — no forming required
- One sided wall systems available
- Halogen, asbestos and solvent free
- Operational immediately after installation
- Smoke resistant

### Base materials

Concrete, Porous concrete, Masonry, Drywall

### Approvals Internationally tested and approved

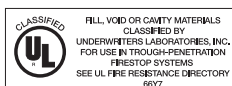

**Other tests include :** ASTM E 814 : ASTM E 84 : UL 1479

### For use with

- Walls (UL tested up to max. opening 72” x 36”)
- Floors (UL tested up to max. opening 72” x 36”)
- Concrete, porous concrete, masonry and gypsum wall assemblies
- Wall assemblies rated up to 4 hours
- Floor assemblies rated up to 3 hours

## Firestop block CFS-BL

Ordering designation	Sales pack quantity	Item number
CFS-BL	1 pc	2030020



### Key applications & advantages

- Excellent for re-penetration with new cables
- Economical in use owing to short installation time
- No special tools required
- Functional after installation
- Dust and fibre free
- Smoke and gas tight



### Storage

- Store only in the original packaging in a location protected from moisture and direct sunlight at a temperature of 0°C to 38°C.



## CFS-BL Firestop block

### Technical data

Density	0.27 g/cm <sup>3</sup>
Colour	Red
Application temperature range	5°C - 40°C
Temperature resistance	(-15° C to 60° C)
Intumescent activation	200 °C
Expansion ratio (unrestricted)	Up to 1:3
Dimensions (LxWxH)	200 x 130 x 50 mm

### Opening:

- Clean the opening.
- Cables and cable supporting structure must be installed in compliance with local building and electrical standards.

### Installing firestop blocks

- a) If no cables are laid, build up CP 657 firestop blocks firmly seated, positioned longitudinally to the opening, the bigger dimension corresponding to the floor or wall thickness.  
Build them up as masonry bond, no mastic is needed between each layer.  
Apply a bead of CP 611A/FS-One Max around the opening at the contact point between the block and the concrete.  
In floor application, fix a wire mesh to help during the construction.
- b) If cables are laid, build up CP 657 firestop blocks firmly seated, positioned longitudinally to the opening, the bigger dimension corresponding to the floor or wall thickness.  
Build them up as masonry bond, no mastic is needed between each layer.  
Cut the blocks with a knife to suit the laid cables and completely fill cable spaces, gaps and joints with CP 611A/FS-One Max intumescent firestop mastic.

### Note

- Firestop blocks may be laid longitudinally and width wise in the direction of the opening.
- CP 611A/FS-One Max can be smoothed with the aid of a paintbrush before skin forms.
- Floors seal must be protected from loads.

### Re-installing cables

- Remove a block from the seal and cut it to shape.
- Install the cable and re-lay the block in compliance with the approval. Fill gaps and spaces with CP 611A/FS-One Max.



Clean the opening



a) Build up blocks



b) Cut blocks to size if cables are in place



Build up blocks to fill the opening



Fill gaps



Fasten installation plate in place (if required)

### Dimensions

#### Dimensions:

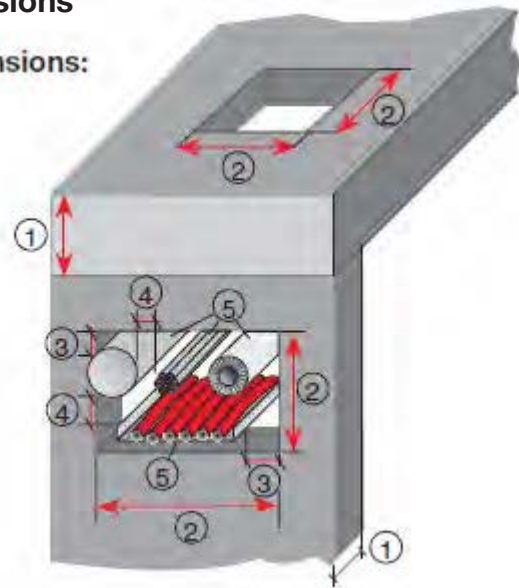

### The following dimensions must be observed when making the seal per BS

	Wall (mm)	Floor (mm)
Min. thickness of building component	100	150
Min. distance to next opening	600 x 700	830 x 900
Min. distance between penetrating items and opening surface:		
- Cables tray	60 mm	60 mm
- PVC pipes	100 mm	100 mm
- Metal pipes	100 mm	100 mm
Min. distance between penetrating items.	25 mm	25 mm
Max. dimensions of penetrating items		
Max. opening loading (as % of opening size)	60 %	60 %
Cables diameter	26mm	26mm
PVC pipe diameter	50mm	50mm
Insulated metal pipe diameter	168mm	/
Metal pipe diameter non insulated	60mm	60mm

- Single cables can be run through joints between blocks, and also a hole can be drilled through a brick using a sharpened piece of metal tubing.

### Safety precautions

- Please refer to MSDS data sheet available as a download from the Technical Library on the Hilti web site at [www.hilti.co.za](http://www.hilti.co.za)

## CFS-CU/CP 651N Firestop cushions

### Areas of application:

- Permanent firestopping in cable penetrations through walls and floors, particularly where flexibility is required due to frequent changes in cabling
- Sealing penetrations for single or bunched cables and openings in floors and walls for PVC pipes up to 50 mm diameter
- Temporary sealing of openings or breaches in floors and walls during construction work

### Fast, approved and reusable.

- Very economical in use thanks to improved cushion dimensions
- Suitable for openings of all sizes up to 1200x1500 mm in walls and 1000x700 mm (700x 3 mm) in floors
- Fully functional immediately after installation
- Quick, easy installation and removal, thus especially recommended for use where cable installations undergo frequent modification
- Re-usable, cost-saving solution
- Also suitable for use in drywall partitions
- Tear-resistant and dust-free for trouble-free, easy installation – even in sensitive environments
- Hilti CP651N has not only been tested with current cable arrangements in accordance with EN 1366-3 but also with expected future EN cable configurations comprising a much larger variety of cables.



### Key applications & advantages

- Permanent firestopping of cable penetrations in walls and floors
- Cables, cable bundles and 50 mm PVC pipes
- Temporary sealing of openings in floors and walls through the construction phase
- Quick and easy installation
- No special tools required
- Smoke and gas tight

## Approvals Internationally tested and approved

# EN 1366-3

### Storage

- Store only in the original packaging

**CFS-CU/CP 651N Firestop cushions** \*ON DEMAND ITEM - Please ask your field engineer or account manager for more information (subject to change)



Ordering designation	Dimensions (LxWxH)	Sales pack quantity	Item number
CFS-CU/CP 651N-S	300 x 40 x 30 mm	30 pc	382624
CFS-CU/CP 651N-M	300 x 80 x 30 mm	15 pc	382625
CFS-CU/CP 651N-L	300 x 170 x 30 mm	6 pc	382626

## CFS-CU/CP 651N Firestop Cushions

	Wall	Floor
Min. building component thickness	100 mm	150 mm
Max. opening size	Width Height/length	1200 mm 700 mm unlimited
Min. distance of cable run from opening		40 mm 40 mm
Min. distance between cable trays	Horizontal Vertical	0 mm 80 mm 0 mm 80 mm
Min. distance between openings		200 mm 200 mm
Max. cable loading (as% of opening size)	60%	60%

### Technical data

Shelf life <sup>1)</sup>	Not relevant
Application temperature range	-30 - 35 °C
Base materials	Drywall, Concrete, Masonry
Approx. density	350 kg/m <sup>3</sup>
Expansion ratio (unrestricted, up to)	1:3
Fire rating	See Approvals
Colour	White

<sup>1)</sup> at 77°F/25°C and 50% relative humidity; from date of manufacture

## Installation instructions for CFS-CU/CP 651N

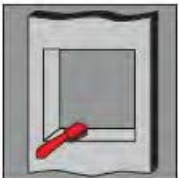

Clean the opening. Cables and cable supporting structures must be installed and fastened in compliance with standards

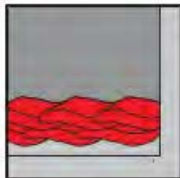

Cushion arrangement without cables running through wall partition; for drywall framing of opening required (gypsum panels)



Cushion arrangement with cables running through wall partition

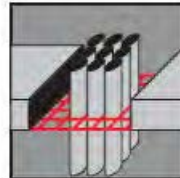

For floor openings fasten wire mesh in place when closing the opening

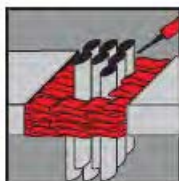

Cushion arrangement in floor. Seal gaps between cables and CP 651N with CP 606 if required (please refer to approval)



Wrap cable/cable tray resp. pipes running through opening with CP 651N-L and fix with wire if required (please refer to approval)



Fasten identification plate in place (if required)

## Dimensions

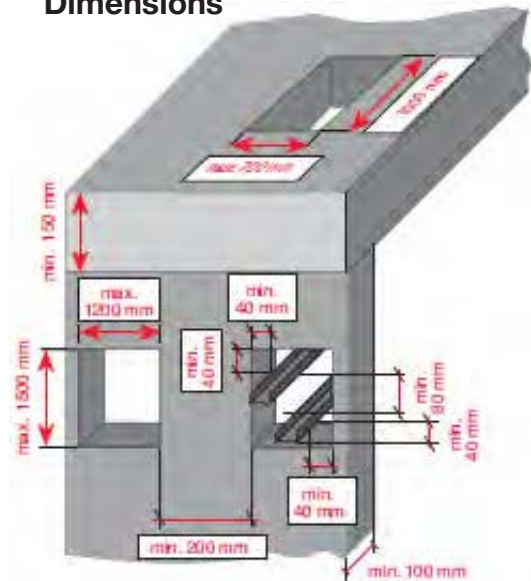

### Note

- Insert the first layer of CFS-CU/CP 651N underneath the cables if possible
- Overlap (> 20 mm)
- Shift next layer 1/2 width of cushion (stretcher bond)
- Openings in floors should have wire mesh (wire > 5 mm dia./mesh □ 50x50 mm) secured on the underside with Hilti anchors e. g. HEH, DBZ etc. The CFS-CU/CP 651N firestop cushions must be laid on the wire mesh, overlapping by ca. 1/2 width of cushion resulting in an overall installation depth of 150mm
- Seal off the opening with CFS-CU/CP 651N tightly
- If cable penetration must carry permanent identification mark in the form of an installation plate. Enter the appropriate details on the installation plate and mount it in a visible position beside the cable penetration
- Floor seals must be protected from loading and theft using wire mesh
- Do not use damaged cushions

### Inspection

- Check that the cushions have been installed in compliance with regulations

### Not for use...

- With folded and coiled sheet-metal or cast-iron pipes (not tested)
- In highly corrosive surroundings
- In areas submerged in water
- In installations where high smoke pressure resistance required

### Safety precautions

- Keep out of the reach of children
- Observe the EC safety data sheet

### Storage

- Store only in the original packaging

## CFS-P PA Firestop putty pad

### Product description

An intumescent mouldable putty pad that has been designed for use with electrical back-boxes. CP 617 reinstates acoustic properties and provides fire rating of up to 2hrs in drywall.

### Areas of application:

- Plastic or metal back-boxes
  - Can be used for commercial and residential applications
  - Acoustically rated drywall
  - General gypsum wall assemblies
  - Substitutes the need for baffle boxes
- Pads can be fitted to the inside or outside of the box. Tested to EN1366-3 and BS476 to include 1hr and 2hr drywall on unsupported outlet boxes.

### Product features

- Pad can be moulded by hand to fit any size of outlet box
- Quick and simple to install

### Base materials

Drywall



## Approvals Internationally tested and approved

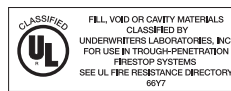

**EN 1366-3**

### Installed cost benefits

Using this device could have your costs compared to traditional methods.

- No baffle boxes
- Elimination of sacrificial/false walls
- Reduced labour
- Very fast and simple to install

For examples from companies who have realised this saving already, look at the case studies at [www.hilti.co.za](http://www.hilti.co.za)

### Sustainability

- Less plasterboard required
- Minimum 30 year life
- No wastage
- Recyclable packaging

**CFS-P PA Firestop putty pad** \*ON DEMAND ITEM - Please ask your field engineer or account manager for more information (subject to change)



Ordering designation	Dimensions (LxWxH)	Sales pack quantity	Item number
CFS-PPA 170x170	170 x 170 x 3 mm	20 pc	39214



## CFS-P PA Intumescent acoustic putty pad

### Technical data

Base materials	Gypsum
Colour	Red
Application temperature range	0 - 40 °C
Temperature resistance range	-20 - 60 °C

### Acoustic and Fire Tests

- Tested in Lafarge, Knauf and BG walls
- The product is shown in the latest BG White Book

The pads have been proven to reinstate the full acoustic performance of a  $R_w=65\text{dB}$  specification wall. There was no difference in acoustic rating between the original, unpenetrated wall, and the same wall with 4 pairs of double sockets fitted back-to-back (2 pairs each side) with pads inside.

The pads have also been fire tested on both metal and plastic back-boxes in drywall. The pads reinstate the fire integrity of the original wall up to 2 hours rating.

### Installation instructions for CFS-P PA

The pad can be fitted inside or on the back of the box. Gloves are recommended when handling the product. Before handling, read material safety data sheet and product label for safe usage and health information

- The pad may be installed in one piece, or in several sections, providing all joints are moulded together.
- Take care to seal any gaps between the box and the plasterboard

### Fitting on the back (plastic boxes)

- Simply mould the pad over the back of the box
- Take care to seal around the cable.

### Fitting on the back (metal boxes on noggin)

- Sandwich the pad between the back of the box and the noggin
- Attach the box by screwing through the box, through the pad and into the noggin
- Mould the pad around the box
- Take care to seal around the cable



The above applications are not exhaustive. For further details please contact your local Hilti representative

## CP 670 Fire safety board system

### Product description

Hilti CP670 is an innovative system for fast, reliable and cost effective firestopping of wall and floor openings – especially large ones. Tested to both BS476 Part 20 and EN 1366-3.

### Areas of application:

- Extended approvals for large diameter cables, damped penetrations and double board usage
- Single cables, cable bundles, cable tray air ducts and pipes
- Combustible and non combustible pipes
- Large penetrations possible up to 5 meters high by any length

### Product features:

- Odourless and solvent free
- Less prone to damage due to pliancy of the material and the resilient elastic coating
- Approved for a wide range of applications
- Fast tight seal, less sealant required for gap filling

### Base materials

Drywall, Masonry, Concrete

### Storage

- Store only in the original packaging in a location protected from moisture and direct sunlight at a temperature of 5°C to 37°C.
- Observe expiry date on packaging.

### Approvals Internationally tested and approved



## EN 1366-3

### Technical data

Shelf life <sup>1)</sup>	Not relevant
Application temperature range	5 - 40 °C
Base materials	Drywall, Concrete, Masonry
Fire rating	See Approvals
Colour	White

<sup>1)</sup> at 77°F/25°C and 50% relative humidity; from date of manufacture



### Key applications & advantages

- Permanent firestopping of blank openings, cables, cable trays, non-combustible and combustible pipes in medium to large wall and floor openings
- Ideal for large openings
- Solvent and silicone-free
- Fully functional immediately after installation

## CP 670 Fire safety board system

Ordering designation	Dimensions (LxWxH)	Sales pack quantity	Item number
CP 670 1200x600x50 white	1200 x 600 x 50 mm	16 pc	236673



## CP 670 Fire safety board system

### General installation information

#### Opening:

- Clean the opening. Do not pre moisten opening surfaces.
- Cables and cable supporting structures must be dry and free from dust, grease or oil, and installed in compliance with local building and electrical standards.

#### Application

##### a) Preparation

- Mix the CP 670 coating well.
- Separated water in the container must also be mixed in.
- Coat mineral wool panel (minimum density of 160 kg/m<sup>3</sup> and thickness of 50 mm) with CP 670. The required dry film thickness of CP 670 coating is 0.7 mm (1 coat). If a pre coated mineral wool panel is used, this operation is unnecessary.

##### b) Fitting of boards

- Cut the coated mineral wool panel to size. Coat the surface of the opening with CP 606 sealant and insert the panel flush with the opening edge. Seal around the opening and between the cables with CP 606 sealant or CP 611A as appropriate. Pack any gaps or openings with mineral wool and seal with CP 606 sealant.

#### Note

CP 670 Fire Safety Coating can be used where cutting has caused exposed mineral wool to appear. In addition, the coating can be applied if wool is used to pack gaps or coat back on cables if required.

### Detailed installation information

Detailed installation information

#### 1 – Application

Used to seal penetrated and unpenetrated openings within concrete, masonry and dry (partition) wall constructions to reinstate their fire resistance performance. Also used, in the internally framed version, to provide independent partition wall penetration sealing system constructions of up to 5 m height. The three available systems, single layer unframed (Type A), double layer unframed (Type B) and double layer with internal supporting steel frame (Type C) provide up to 240 minutes fire resistance, depending on the system used and the service application. The three construction types provide the most comprehensive and versatile wall mounted firestopping system available.

#### 2 – Description and Components

The basic description and primary components of the system(s) are as follows:

##### 2.1 - Type A

Single layer unframed system 50 mm thick batt. Can be installed in apertures within concrete, masonry or partition wall constructions of 100 mm minimum thickness with a maximum aperture size of 2400 mm high by 5000 mm wide. Apertures in partition wall must be framed out with steel partition studs. The system will accommodate electrical cables of up to 75 mm diameter, with or without cable trays, steel pipes of up to 250 mm diameter, copper pipes of up to 108 mm diameter, steel trunking of size up to 250 mm square and various plastics pipes of up to 160 mm diameter, using CP 644 or CP 643 pipe collars, in recessed or surface mounted installation details. System requires CP 670 Fire Safety Board (1200 mm by 600 mm), CP 670 Fire Safety Coating and CP 606 Firestop Sealant. Depending on service applications may also require CP 611A Pressure Exerting Intumescent.

##### 2.2 - Type B

Double layer unframed system 100 mm thick (two 50 mm thick batts). Can be installed in apertures within concrete, masonry or partition wall constructions of 100 mm minimum thickness with a maximum aperture size of 2400 mm high by 5000 mm wide. Apertures in partition wall must be framed out with steel partition studs.

The system will accommodate electrical cables of up to 75 mm diameter, with or without cable trays, steel pipes of up to 250 mm diameter, copper pipes of up to 108 mm diameter, steel trunking of size up to 250 mm square and various plastics pipes of up to 160 mm diameter, using CP 644 or CP 643 pipe collars, in recessed or surface mounted installation details. System requires CP 670 Fire Safety Board (1200 mm by 600 mm), CP 670 Fire Safety Coating and CP 606 Firestop Sealant. Depending on service applications may also require additional service insulation material (for pipes etc).

##### 2.3 - Type C

Double layer framed system 130 mm thick (two 50 mm thick batts with 30 mm deep System ML support frame). Can be installed in apertures between concrete and/or masonry constructions up to a maximum height of 5000 mm by and width. May also be installed within pre-prepared apertures in partition wall constructions of 130 mm minimum thickness with a maximum aperture size of 2400 mm high by 5000 mm wide. For use in partition walls the vertical steel internal ML channel members must be installed during construction of the wall assembly and fixed to the structural floor and ceiling. The channels may be installed coincident with the partition vertical studs. Apertures in partition wall must be framed out with steel partition studs. The system will accommodate electrical cables of up to 75 mm diameter, with or without cable trays, steel pipes of up to 250 mm diameter, copper pipes of up to 108 mm diameter, steel trunking of size up to 250 mm square and various plastics pipes of up to 160 mm diameter, using CP 644 or CP 643 pipe collars, in recessed or surface mounted installation details. Additionally curtain type dampers of overall size up to 1200 mm by 1200 mm can be accommodated, supported by the internal steel framing. NOTE: Multi blade dampers can only be used if they have previously been tested in a partition wall construction. System requires CP 670 Fire Safety Board (1200 mm by 600 mm), CP 670 Fire Safety Coating, CP 606 Firestop Sealant, 3mm diameter steel pins and 30 mm diameter non return (speed) washers. Depending on service applications may also require additional service insulation material (for pipes etc).

#### Installations instructions for CP 670



Clean the opening



Coat mineral wool panel with CP 670



Coat cut edges with CP 606



Fit mineral wool panel



Fill gaps with CP 606



Fasten installation (if required)

## CFP-CI/CP 678 Firestop cable coating

### Product description

Hilti CFP-CI is a ready to use, water based, intumescent cable coating, which can be applied by brush or airless spray to prevent the propagation of fires along internal electrical cables. Cables coated with CP 678 will exhibit increased protection in the event of a fire. Also suitable for protecting against spread of flame on timber panels.

### Main applications

- Power plants.
- Telecommunication complexes.
- Industrial plants.
- Petrochemical plants.
- Paper mills.
- Factories and production facilities.

### Product features:

- Water soluble, odourless and solvent free.
- Rapid drying.
- Remains flexible when dry.
- Intumescent.
- Free of fibres, or as asbestos.
- No derating effect on cables.
- Compatible with the sheathing of electrical cables.

### Approvals Internationally tested and approved



Other tests include : IEC 60332-3



### Key applications & advantages

- Protection of cables and bunched cables on cable trays in indoor installations
- Meets IEC 60332-3-22 Category A standard for reduced spread of flame
- Factory Mutual Approved (fire retardant coating of electrical cables)
- Intumescent
- Water soluble, odourless and solvent free

### Technical data

Shelf life <sup>1)</sup>	18 Months
Application temperature range	5 - 40 °C
Approx. curing time <sup>2)</sup>	24 h
Approx. wet density	1300 kg/m <sup>3</sup>
Approx. wet density	1300 kg/m <sup>3</sup>
LEED VOC	60 g/l
Building material class (according to DIN 4102)	B2
Storage and transportation temperature range	5 - 30 °C
Colour	White

<sup>1)</sup> at 77°F/25°C and 50% relative humidity; from date of manufacture

<sup>2)</sup> at 75°F/24°C, 50% relative humidity

## CFP-CI/CP678 Firestop cable coating



Ordering designation	Sales pack quantity	Item number
CFP-CI 20KG	1 pc	334892

## CFP-CI/CP678 Firestop cable coating

### Installation Instructions for CFP-CI/CP678 cable coating



#### Opening:

- Clean the cables. The cables and cable supporting structures must be dry and free from dust, grease or oil and installed in compliance with local building and electrical standards.
- Prepare the cable coating. Thoroughly mix the CFP-CI/CP678 coating. Any separated water in the container must also be mixed in. Do not add water.
- Apply CFP-CI/CP678 cable coating to all areas of the cables and cable run over the required length. This can be done using a paint brush, roller or airless spray gun with the recommended 0.029" nozzle and 40° spray angle.
- Each application will achieve a dry film thickness of approx. 0.5 mm. To meet IEC 332 requirements, the dry film thickness must be at least 0.5 mm. For Factory Mutual requirements the dry film thickness must reach 1.6 mm.

#### Coverage

- On a flat surface coverage will be approximately 650 gm per m<sup>2</sup> (at 0.5 mm DFT) .
- On cable bundles and cable trays allow 1 to 1.5 kg per m<sup>2</sup> (at 0.5 mm DFT) depending on volume of cables, method of application and wastage (ie. over spray).

#### Do not

- Paint over the coating.
- Use outside or in damp rooms.
- Apply to uninsulated cables.

#### Safety precautions

- Keep out of the reach of children.
- Observe the safety data sheet.
- Wear suitable gloves and eye protection.

#### Storage

- Store only in the original packaging in a location protected from moisture.
- Observe expiry date on bucket.
- Store at temperatures between 5°C and 37°C.

The above applications are not exhaustive. For further details please contact your local Hilti representative

## CFP-C E/CP 679A Ablative firestop cable coating

### Product description

CP 679A is a solvent and chlorine-free dispersion with flame retarding pigments ablations coating compound. Asbestos and halogen free. CFP-C E/CP 679A is an ablation product, which undergoes an endothermic reaction when subjected to fire. This means that evaporation of the water released by the heat has a crucial effect on the spreading of the fire.

### Fields of applications

CFP-C E/CP 679A is a universal fire retardant coating used on cables laid horizontally or vertically. It can be used both for indoor or outdoor applications.

- Offshore exploration, production & refining
- Oil & Gas
- Power Plants

### Product features:

- Viscoelastic, remains elastic even in thick coats.
- Impermeable to water.
- Resistant to oil and petrol spills.
- Weatherproof, virtually odourless and Environmental friendly..

### Approvals Internationally tested and approved



Other tests include : IEC 60332-3



### Key applications & advantages

- Protection of cables and bunched cables on cable trays
- For use in the oil and gas industry, offshore installations, petrochemical and power plants
- Easy to apply using a paint brush, roller or airless spray gun (recommended nozzle size 0.58 - 0.63 mm)
- Ablative ready-to-use coating
- Odourless and water based

### Technical data

Shelf life <sup>1)</sup>	12 Months
Application temperature range	5 - 45 °C
Approx. curing time <sup>2)</sup>	24 h
Approx. wet density	1350 kg/m <sup>3</sup>
Approx. wet density	1350 kg/m <sup>3</sup>
Storage and transportation temperature range	5 - 30 °C
Colour	White

<sup>1)</sup> at 77°F/25°C and 50% relative humidity; from date of manufacture

<sup>2)</sup> at 75°F/24°C, 50% relative humidity



## CFP-CE/CP 679A Ablative firestop cable coating

Ordering designation

CFP-CE/CP 679A 20KG

Sales pack quantity

1 pc

Item number

372097

www.hilti.co.za | 08000 23331

## CFP-C E/CP 679A Ablative firestop cable coating

### Installation Instructions



#### Opening:

- Clean the cables. The cables and cable supporting structures must be dry and free from dust, grease or oil, and installed in compliance with local building and electrical standards.
- Prepare the cable coating. Thoroughly mix the CFP-C E/CP 679A coating. Any separated water in the container must also be mixed in. Do not add water. CFP-C E/CP 679A should be applied at its original viscosity.
- Apply CFP-C E/CP 679A cable coating to all areas of the cables and cable run over the required length. CP 679A can be applied with conventional brush, roller or with airless spraying equipment. It is advisable to use nozzle openings 0.58 to 0.63 mm or 0.023 to 0.025 inch.
- CFP-C E/CP 679A can also be applied in several thinner coats, each of them being allowed to dry before recoating.
- A single coat can achieve a dry film thickness (DFT) of approx. 1.0 mm (0.04 in.). Please note that a 1.0 mm (0.04 in.) DFT is required to meet ABS (American Bureau of Shipping) and/or DNV (Det Norske Veritas) rules.

#### Coverage

- On bunched cables the coverage rate of CFP-C E/CP 679A will be approximately 1.7 kg per m<sup>2</sup> (at 1.0 mm DFT).

### Installation instructions



#### Do not

- Dilute with water.
- Apply to uninsulated cables.

#### Safety precautions

- CFP-C E/CP 679A has no toxic additives and therefore only requires such measures as are to be adopted when applying paints.
- Remove splashes arising during application immediately with water.
- Keep out of the reach of children.
- Observe the material safety data sheet.
- Wear suitable gloves and eye protection.

#### Storage

- Store only in the original packaging in a dry location protected from moisture.
- Observe expiry date on bucket.
- Store at room temperature, free from frost.

The above applications are not exhaustive. For further details please contact your local Hilti representative

## CF125-50 Dispenser foam

### Product description

CF 125-50 dispenser backing foam is a one component ready-to-use polyurethane system, to be used in conjunction with firestop sealants and intumescent sealants.

### Areas of application:

- Insulating and sealing doors and windows in fire rated building elements.
- Backfilling around service penetrations prior to being used as backing material for CP 601S, CP 606 and CP 611A Passive Fire Resistance sealants and mastics.
- Tested in accordance with the criteria laid down in BS476 Part 20.

### Product features:

- Excellent adhesion
- Moisture cured
- Ozone friendly propellant

### Base materials

Concrete, Masonry, Timber, Brickwork  
(Walls and floors > 100mm)

## Approvals Internationally tested and approved

**British Standard**  
**BS 476**



### Curing characteristics

Note Hardening characteristics are temperature and humidity dependant.

non-tacky: 10-20 minutes

ready-to-cut pack: 20-40 minutes

ready to firestop: approx 30 minutes

### Recommendations

- Joint sides are to be sound, free from dust, oil or grease.
- Base materials must be moistened with water to aid adhesion and curing.
- Deep cavities to be filled in successive layers. Ensure top surface of the preceding layer is sufficiently nontacky before applying the next layer. Spray individual layers with water.
- Remove spillage with CF-R1 cleaner before foam cures. Once cured remove mechanically.
- Base material and ambient temperature to be 50C minimum.

### CF125-50 Dispenser foam

Ordering designation	Package contents	Sales pack quantity	Item number
COMBO CF 125-50 STARTER KIT	12x Dispenser foam CF 125-50 750ML, 1x Dispenser gun CF DS-1, 1x Cleaner CFR1 500ML	1 pc	3502395
CF 125-50 750ML		1 pc	259628



### Key applications & advantages

- Insulating gaps around window frames, cooling equipment and pipes, heating pipes, baths, wood floors, air-conditioning equipment, air ducts
- High yield
- Stop-and-go controlled dispensing
- Insulating gaps around window frames, cooling equipment and pipes, heating pipes, baths, wood floors, air-conditioning equipment, air ducts

### Storage

- Store in original packaging in a location protected from frost, moisture, sunlight and at a temperature of 50C to 250C.
- Do not allow canister to exceed 500C.
- Observe expiry date on bottom of cans.





## CF125-50 Dispenser foam

### Technical data

Foam yield (up to)	50 l
Approx. tack-free time (at 23°C / 50% rel. humidity)	10 min
Approx. cut time (at 23°C / 50% rel. humidity)	20 min
Thermal conductivity ( $\lambda$ approx. value)	0.04 W/mK
Shear strength (approx.)	0.06 N/mm <sup>2</sup>
Approx. tensile strength	0.06 N/mm <sup>2</sup>
Application temperature range	5 - 30 °C
Colour	Manila

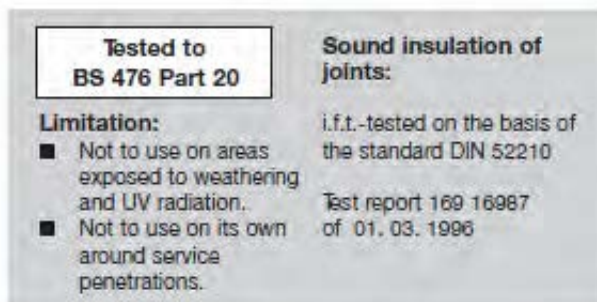

### Application Details

- Read and follow all instructions/warnings on can label.
- The base material must be wet to enable optimal foam output volume and to prevent subsequent swelling.
- Shake can of CF 125-50 foam thoroughly before use (minimum of 20 seconds).
- Remove the protective cap from the can.
- The CF 125-50 Foam container can now be screwed onto the CF DS1 dispenser.
- The foam can now be used adjusting the flow rate by means of the flow adjustment screw at the rear of the dispenser.
- When the work with the CF 125-50 foam system is complete, close the trigger lock. A foam can must be attached to the dispenser at all times.
- The surface of the base material must be free of dust and grease.
- To fill deep cavities apply foam in successive layers. Ensure the top surface of the preceding layer is sufficiently non-tacky before applying the next layer. When applying foam in layers, spray the individual layers with water.
- The foam will not blend to teflon, silicone or form work release agent.

### Safety precautions

- Please refer to MSDS data sheet available as a download from the Technical Library on the Hilti web site at [www.hilti.co.za](http://www.hilti.co.za)

### Overlaying with Fire Resistant Sealants/Mastics

- After 20-40 minutes, once a skin has formed, gently push back foam to required depth. Alternatively, wait until full cure and rake out or cut back foam to required depth.

### CFS-S SIL/CFS-S ACR for joint applications

Cartridge volume = 310 ml

a = Joint width in cm

b = product depth in cm (see 'Tested Applications')

Linear meter per cartridge =  $\frac{3.10}{a \times b}$

e.g. a floor joint 20 mm wide with product depth of 10 mm:

Therefore linear meters per cartridge =  $3.10 / (2 \times 1) = 1.55$  meter per cartridge

for one side of the floor

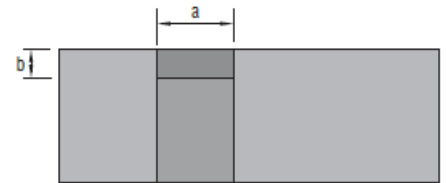

### CFS-S SIL/CFS-S ACR for pipes and bunched cables

Cartridge size = 310 ml

a = Hole diameter in cm

b = Product depth (see approvals)

c = pipe or bunched cable diameter in cm

No. of cartridges required =  $\frac{(a^2 - c^2) \times b}{395}$

e.g. 50 mm pipe in 150 mm hole:

Number of required cartridges =  $\frac{(152 - 52) \times 4}{395}$

= 2 cartridges for one side (check approvals if one or two sides are required)

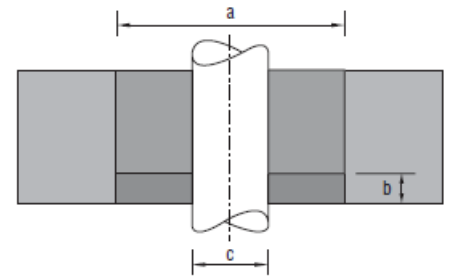

### CFS-F SOL Expanding Fire Seal

Foam installation thickness:

Surface area of Seal (mm x mm)	Diameter of Seal mm		No. of CFS-F SOL cartridges			
			Cable loading (as % of opening size)			
			0%	10%	30%	60%
0.005	ø90	50 x 100	1	1	1	1
0.01	ø120	100 x 100	1	1	1	1
0.015	ø140	100 x 150	2	2	1	1
0.02	ø160	100 x 200	2	2	2	1
0.025	ø180	100 x 250	3	2	2	1
0.03	ø200	100 x 300	3	3	2	1
0.04	ø220	200 x 200	4	3	3	2
0.045	ø240	200 x 225	4	4	3	2
0.05	ø250	200 x 250	5	4	3	2
0.06	ø280	200 x 300	5	5	4	2
0.07	ø300	200 x 350	6	6	4	3
0.08	ø320	200 x 400	7	6	5	3
0.09	ø340	300 x 300	8	7	6	3
0.1	ø350	300 x 330	8	8	6	4
0.12	ø400	300 x 400	10	9	7	4
0.16	-	400 x 400	13	12	10	6
0.20	-	400 x 500	17	15	12	7

### CFS-BL Firestop Flexible Brick

Brick dimension 200 x 130 x 50 mm

a = opening width in cm

b = opening length in cm

Opening with 30% cross sectional area of services multiply the blank opening results by 0.7

Opening with 50% cross sectional area of services, multiply the blank opening by 0.5

#### Header orientation

e.g. 1 metre by 1 metre opening

Blank opening =  $\frac{a \times b}{65}$

Number of bricks required =  $\frac{100 \times 100}{65} = 154$  bricks

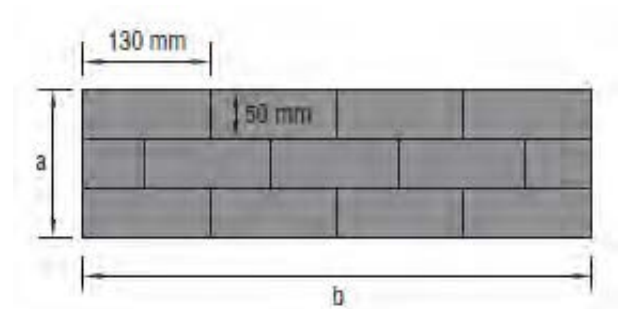

## CFS-M RG/CP 636 Firestop Mortar

20 kg bags yield 22.2 litres

a = opening depth in cm

b = opening length in cm

c = opening width in cm

### Blank opening

Number of bags required =  $a \times b \times c$

22,000

e.g. 100 mm thick floor with 1 meter x 1 meter opening:

Therefore number of bags required =  $10 \times 100 \times 100 = 5$  bags

22,000

Opening with 30% cross sectional area of services

Number of bags required =  $a \times b \times c \times 0.7$

22,000

Opening with 50% cross sectional area of services

Number of bags required =  $a \times b \times c \times 0.5$

22,000

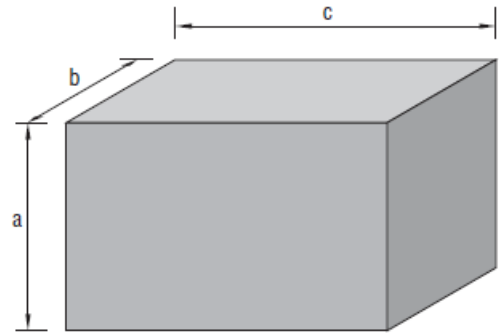

## CFS-CU/CP 651N Firestop Cushions

Opening (m <sup>2</sup> )	Cable load 0%			load 10%			cable load 30%			cable load 60%		
	0	1	4	-	-	-	-	-	-	-	-	-
0.01	0	1	4	-	-	-	-	-	-	-	-	-
0.02	3	2	3	3	2	2	-	-	-	-	-	-
0.04	6	2	1	5	2	1	5	2	1	-	-	-
0.05	8	2	2	8	2	1	7	4	1	-	-	-
0.1	16	4	2	18	3	2	15	3	2	12	4	2
0.2	32	7	3	31	6	3	23	6	3	20	5	3
0.4	65	15	6	63	13	6	51	14	5	36	9	4
0.5	80	19	8	76	16	7	64	13	5	40	11	4
0.6	96	23	9	90	20	8	74	16	7	52	12	6
0.8	128	29	11	118	26	10	92	20	8	66	13	6
1.0	160	36	13	148	32	12	119	25	10	78	18	8
1.2	182	47	15	169	39	13	136	31	11	86	24	9
1.4	215	54	16	201	48	15	164	38	12	109	31	10
1.6	257	61	18	232	55	16	189	43	12	120	36	10
1.8	298	68	21	278	61	19	218	48	15	136	41	12
Cushion	CP651N-L	CP651N-M	CP651N-S	CP651N-L	CP651N-M	CP651N-S	CP651N-L	CP651N-M	CP651N-S	CP651N-L	CP651N-M	CP651N-S

## Hilti CP 670 Ablative Firestop Coated Board System

Opening Size (m <sup>2</sup> )	L x w (mm)	Degree of Load			
		0%	10%	30%	60%
		CP 670 (kg)	CP 670 (kg)	CP 670 (kg)	CP 670 (kg)
0.1	100x1000	0.30	0.28	0.22	0.12
0.5	500x1000	1.50	1.34	1.04	0.60
0.8	800x1000	2.40	2.18	1.68	0.98
1.0	1000x1000	3.00	2.70	2.10	1.20
1.5	1000x1500	4.48	4.00	3.20	1.80
2.0	1000x2000	6.00	5.00	4.20	2.40
2.4	1200x2000	7.20	6.40	5.00	2.90

• Please note that cable/cable tray coating is not included in these consumption values

### Note

- Required kg of CP 670 Fire Safety Coating based on a dry thickness of 0.77mm considering coating on either side.
- Required kg of CP 606 filler depending on number of cut edges, opening size, cable arrangement and number of cable trays
- All consumption values are orientation values without consideration of cable coating and left gaps and voids.

## Most Common Systems for Through Penetrations

Concrete Floor/ Wall or Block Wall						
Description	CP 606	FS-ONE Max	CP 648	CP 643N/CP 644	CP 636	CP 620
Metal Pipe	C-AJ-1372 C-AJ-1435 W-J-1124	C-AJ-1226 C-AJ-1380 C-AJ 1278 W-J-1067			C-AJ-1140	
Plastic pipe max. 2" diameter		C-AJ-2567				
Plastic pipe more than 2" diameter		C-AJ-2335	C-AJ-2342 C-AJ-2393 C-AJ-2488 C-AJ-2420 W-J-2121	C-AJ-2109		
Cable Bundle	C-AJ-3181	C-AJ-3180 C-AJ-3095				
Cable Trays		C-AJ-4071			C-AJ-4017	C-AJ-4054
Busbar		C-AJ-6017			C-AJ-6006	
Metal Pipe with Glass-fiber Insulation	C-AJ-5265	C-AJ-5091 C-BJ-5006 W-J-5042				
Metal Pipe with AB/PVC Insulation		C-AJ-5090 W-J-5041				
Sheet Metal Duct	C-AJ-7051 W-J-7085	C-AJ-7111 W-J-7029				
Multiple Penetrants		C-AJ-8143				C-AJ-8180 C-AJ-8096 W-J-8017
Gypsum Walls						
Description		FS-ONE Max	CP 648	CP 643N/CP 644		
Metal Pipe		W-L-1054				
Plastic pipe max. 2" diameter		W-L-2128				
Plastic pipe more than 2" diameter			W-L-2411	W-L-2078		
Cable Bundle		W-L-3065				
Cable Trays		W-L-4060				
Metal Pipe with Glass-fiber Insulation		W-L-5029				
Metal Pipe with AB/PVC Insulation		W-L-5028				
Sheet Metal Duct		W-L-7155				
Multiple Penetrants		W-L-8065 W-L-8071				

## Most Common Systems for Through Penetrations

Description	CFS-SP WB	CP 606	CP 601S			
Curtain Wall	CEJ-246-P CEJ-259-P CEJ-127-P CEJ-307-P CEJ-314-P CEJ-421-P	C-AJ-1226 C-AJ-1380 C-AJ 1278 W-J-1067				
Concrete or Block Wall/Floor	HW-D-0097 HW-D-0098	HW-D-0268 HW-D-1009 HW-D-0081 FF-D-1012 FW-D-1012 WW-D-1012	HW-D-1008 FF-D-1011 WW-D-1047			
Gypsum Walls	HW-D-0042	HW-D-0045 HW-D-0184 HW-D-0324				

## The UL Fire resistance nomenclature directory

The Fire resistance Directory utilizes an alpha-numeric numbering system: Basic number system = ALPHA-ALPHA-NUMERIC

### Through – Penetrations

<p><b>The first letter represents what is being penetrated:</b></p> <p>F = FLOOR W = WALLS C = FLOORS OR WALLS (COMBINED)</p>	<p><b>The second letter(s) provide more information about the floor or wall:</b></p> <p>A = CONCRETE FLOORS 5 INCHES THICK OR LESS B = CONCRETE FLOORS GREATER THAN 5 INCHES THICK C = FRAMED FLOORS - FLOOR/CEILING ASSEMBLIES D = STEEL DECK CONSTRUCTION E THRU I = NOT USED AT THE PRESENT TIME J = CONCRETE OR MASONRY WALLS 8 INCHES THICK K = CONCRETE WALLS GREATER THAN 8 INCHES THICK L = FRAMED WALLS - GYPSUM WALLBOARD ASSEMBLIES M = BULKHEADS N THRU Z = NOT USED AT THE PRESENT TIME</p>	<p><b>The four digit number describes the penetrating item(s):</b></p> <p>0000 - 0999 BLANK OPENINGS 1000 - 1999 METAL PIPE CONDUIT OR TUBING 2000 - 2999 NONMETALLIC PIPE CONDUIT OR TUBING 3000 - 3899 CABLES 4000 - 4999 CABLE TRAYS 5000 - 5999 INSULATED PIPES 6000 - 6999 MISCELLANEOUS ELECTRICAL (BUSWAY) 7000 - 7999 MISCELLANEOUS MECHANICAL 8000 - 8999 MIXED PENETRATING ITEMS 9000 - 9999 RESERVED FOR FUTURE USE</p>	<p><b>EXAMPLE: CAJ1150</b></p> <p>C = FLOOR OR WALL PENETRATION A = CONCRETE FLOORS 5" OR LESS J = CONCRETE OR MASONRY WALLS 8" OR LESS 1150 = METAL PIPE, CONDUIT OR TUBING</p>
---	--	--	--

### Joint Systems

<p><b>The first letters identify the type or joint:</b></p> <p>FF = FLOOR-TO-FLOOR WW = WALL-TO-WALL FW = FLOOR-TO-WALL HW = HEAD-TO-WALL CG = WALL-TO WALL JOINTS INTENDED AS CORNER GUARDS BW = BOTTOM OF WALL</p>	<p><b>The third letter signifies the movement capabilities of the joint system:</b></p> <p>S = NO MOVEMENT (STATIC) D = ALLOWS MOVEMENT (DYNAMIC)</p>	<p><b>The four digit number describes the nominal joint width:</b></p> <p>0000 - 0999 LESS THAN OR EQUAL TO 2" 1000 - 1999 GREATER THAN 2" AND LESS THAN OR EQUAL TO 6" 2000 - 2999 GREATER THAN 6" AND LESS THAN OR EQUAL TO 12" 3000 - 3999 GREATER THAN 12" AND LESS THAN OR EQUAL TO 24" 4000 - 4999 GREATER THAN 24"</p>	<p><b>EXAMPLE: HWD0042</b></p> <p>HW = HEAD-OF-WALL D = ALLOWS MOVEMENT (DYNAMIC) 0042 = LESS THAN OR EQUAL TO 2"</p>
--	---	---	---

### Perimeter Fire Containment Systems

<p><b>The first letters identify the perimeter fire containment system:</b></p> <p>CW = CURTAIN WALL</p>	<p><b>The third letter signifies the movement capabilities of the joint system:</b></p> <p>S = NO MOVEMENT (STATIC) D = ALLOWS MOVEMENT (DYNAMIC)</p>	<p><b>The four digit number describes the nominal joint width:</b></p> <p>0000 - 0999 LESS THAN OR EQUAL TO 2" 1000 - 1999 GREATER THAN 2" AND LESS THAN OR EQUAL TO 6" 2000 - 2999 GREATER THAN 6" AND LESS THAN OR EQUAL TO 12" 4000 - 4999 GREATER THAN 24"</p>
--	---	--

## Building regulations (United States of America)

Code References				
Building Code (Year)	Through Penetrations	Membrane Penetrations	Construction Joints	Curtain Wall
IBC (2000)	711.3.1.2			712.4
	711.4.1.2	711.3.2	712.3	
	705.9	711.4.2	705.10	
	706.7		706.8	
	707.8		707.9	
	708.7		708.8	
	709.6		709.7	
	710.5		710.6	
IBC (2003)	712.3.1.2	712.3.2	713.3	713.4
	712.4.1.2	712.4.2	705.10	
	705.9		706.9	
	706.8		707.9	
	707.8		708.8	
	708.7		709.7	
	709.6		711.6	
	711.5			
IBC (2006)	712.3.1.2	712.3.2	713.3	713.4
	712.4.1.1.2	712.4.1.2	713.6	
	705.9		705.10	
	706.7		706.8	
	707.8		707.9	
	708.7		708.8	
	709.6		709.7	
	711.5		711.6	
IBC (2009)	713.3.1.2	713.3.2	714.3	714.4
	713.4.1.1.2	713.4.1.2	714.6	
	706.9		706.10	
	707.7		707.8	
	708.8		708.9	
	709.7		709.8	
	710.6		710.7	
	712.5		712.6	
NFPA 101 (2000)	8.2.3.2.4.1		8.2.2.2	
			A.8.2.2.2	
	A.8.2.3.2.4.2		A.8.3.2	
	8.2.5.2		8.2.5.2	
	A.8.2.5.2		A.8.2.5.2	
		8.3.2		
NFPA 101 (2006)	8.3.5.1	8.3.5.6	8.3.6.5	
	8.3.5.1.3		8.3.6.6	
	8.3.5.1.4			
	8.3.5.5.1			
NFPA 70 National Electrical Code		300-21		

## Building Regulations (England and Wales): Approved Document 'B' Fire Safety (2000 edition)

### In general: Approved Documents

The Approved Document is intended to provide guidance for some of the more common building situations. However, there may well be alternative ways of achieving compliance with the requirements. There is thus no obligation to adopt any particular solution contained in the Approved Document if it is preferred (and can be proven) to meet the relevant requirement by alternative means i.e. by using fire engineering principles to fine tune or value engineer a solution to a specific building.

The Guidance contained in an Approved Document relates only to the particular requirements of the Regulations which that document addresses. The building work may well have to satisfy the requirements of other relevant Building Regulations i.e. non-fire issues.

### Approved Document B (ADB):

The Guidance appropriate to all aspects of Fire Safety is set out separately in Approved Document B. The provisions within the document are closely interlinked and the guidance in the document as a whole should be considered as a package aimed at achieving an acceptable standard of Fire Safety.

The regulations are set out in an Act of Parliament and are therefore law (mandatory requirements). Approved Document B is a guide to a number of methods of complying with the regulations and is not mandatory. A designer may use alternative solutions to those offered in the ADB but must be able to demonstrate that those solutions meet the requirements of the regulations. The guidance is, therefore, functional and not prescriptive. There follow a number of extracts from the Approved Document B Fire Safety relevant to firestopping the fire protection of openings and maintenance of compartmentation, thereby indicating that different design approaches may be taken to satisfy the requirements of the Building Regulations.

### ADB Section 3 and 4: Internal Fire Spread (Structure) Hilti interpretation

The requirements from Part B of Schedule 1 to the Building Regulations 1991:

3. To inhibit the spread of fire within the building, it shall be sub-divided with fire-resisting construction to an extent appropriate to the size and intended use of the building.

#### Limits on application:

Requirement 3 does not apply to material alterations to any prison provided under section 33 of the Prisons Act 1952.

The fire resistance of an element of construction is a measure of its ability to withstand the effects of fire in one or more ways, as follows:

- 4 **Resistance to collapse:** i.e. the ability to maintain load bearing capacity (which applies to load bearing elements only);
- 4 **Resistance to fire penetration:** i.e. an ability to maintain the integrity of the element;
- 4 **Resistance to the transfer of excessive heat:** i.e. an ability to provide insulation from high temperatures.

4. The building shall be designed and constructed so that the unseen spread of fire and smoke within concealed spaces in its structure and fabric is inhibited

## ADB Guidance - Fire resistance

### ADB Section 9 – Compartmentation: junctions

9.6 For compartmentation to be effective, there should be continuity at the junctions of the fire resisting elements enclosing a compartment, and any openings from one compartment to another should not present a weakness.

### ADB Section 9 – Compartmentation Protected shafts

9.7 Spaces that connect compartments, such as stairways and service shafts, need to be protected to resist fire spread between the compartments, and they are termed protected shafts. Any walls or floors bounding a protected shaft, are considered to be compartment walls or floors for the purpose of this Approved Document.

### ADB Section 9 – Compartmentation: junction of compartment wall with roof

9.27 Where a compartment wall or compartment floor meets another wall, or an external wall, the junction should maintain the fire resistance of the compartmentation.

### ADB Section 9 – Protection of Openings and fire stopping Introduction

9.28 A compartment wall should be taken up to meet the underside of the roof covering or deck, with firestopping where necessary at the wall/roof junction to maintain the continuity of fire resistance.

### ADB Section 11 – Protection of Openings and fire stopping Introduction

11.2 If a fire separating element is to be effective, then every joint or imperfection of fit, or opening to allow services to pass through the element, should be adequately protected by sealing or firestopping so that the fire resistance of the element is not impaired.

### ADB Section 11 – Protection of Openings and fire stopping Introduction

11.5 Pipes which pass through a compartment wall or compartment floor (unless in a protected shaft) or through a cavity barrier should meet alternatives A, B, or C below.

#### Alternative A: proprietary seals (any pipe diameter)

11.6 Provide a proprietary sealing system, which has been shown by test to maintain the fire resistance of the wall, floor or cavity barrier.

### Hilti interpretation

The walls and floors that are there to stop the fire spreading from one part of the building to another must not contain any gaps, openings or spaces.

Any services that penetrate a fire resisting element need to be suitably firestopped to eliminate any weakness in that fire resisting element

Firestopping of any Services has to be carried out to maintain the compartment function of the floor and walls forming the protected shaft.

Header joints should be firestopped.

Header joints should be firestopped.

The firestopping must not impair the fire resistance (Integrity and Insulation properties) of the compartmentation i.e. a steel plate would provide integrity but would have no insulation and would therefore not be a suitable firestopping material.

Similarly sand/cement does not intumesce to close plastic pipes or cables, therefore it will not maintain the fire resistance of the compartmentation.

Firestopping products shall have an engineering design assessment to show that they meet this requirement or be subjected to representative fire test results.



## ADB Guidance - Fire resistance

### Alternative B: pipes with a restricted diameter

11.7 Where a proprietary sealing system is not used, firestopping may be used around the pipe, keeping the opening as small as possible. The nominal internal diameter of the pipe should not be more than the relevant dimension given in Table 15

### Alternative C: sleeving

11.9 A pipe of lead, aluminum, aluminum-alloy, fibre-cement or PVC, with a maximum internal diameter of 160 mm, may be used with a sleeving of non-combustible pipe.

The sleeve has to extend 1000 mm from the faces of the wall and be in contact with the pipe. The sleeve has to be firestopped where it penetrates the wall, but there is no need to firestop the service in the sleeve

### ADB Section 11 – Protection of Openings and firestopping: firestopping

11.12 In addition to any other provisions in this document for firestopping:

- s Joints between fire separating elements should be firestopped, and
- s All openings for pipes, ducts, conduits or cables to pass through any part of a fire separating element should be;
  - Kept as few in number as possible, and
  - Kept as small as practicable, and
  - Firestopped (which in the case of a pipe or a duct, should allow thermal movement).

### Re-reinforcement firestopping

11.13 To prevent displacement, materials used for firestopping should be reinforced with (or supported by) materials of limited combustibility in the following circumstances:

- s In all cases where the unsupported span is greater than 100 mm, and
- s In any other case where non-rigid materials are used (unless they have been shown to be satisfactory by test).

### Tested for firestopping

11.14 Proprietary firestopping and sealing systems (including those designed for service penetrations), which have been shown by test to maintain the fire resistance of the wall or other element are available and may be used. Other firestopping materials include:

- s Cement mortar
- s Gypsum based plaster
- s Cement or gypsum based vermiculite/perlite mixes
- s Glass fibre, crushed rock, blast furnace slag or ceramic based products (with or without resin binders), and
- s Intumescent mastics These may be used in situations appropriate to the particular material. Not all of them will be suitable in every situation.

### Hilti interpretation

Pipe size and construction are to be taken into account when firestopping around pipes.

The firestopping should be able to accommodate any thermal or otherwise induced joint movement.

The firestopping needs to be supported if it is flexible or if a ridged firestopping gap is greater than 100mm, unless they have been shown by engineering design assessment that they meet this requirement or have been the subject of representative fire test results.

The firestopping must be shown by engineering design assessment or directly relevant test evidence that it does maintain the fire resistance of the compartment wall or floor.







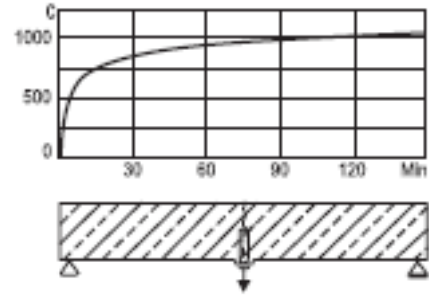

## Tested fasteners for passive structural fire prevention



Tested according to the international standard temperature curve (ISO 834, DIN 4102 T.2)

Tested when set in cracked concrete and exposed to flames without insulating or protective measures



Anchor / fastener	Size	Max. loading (kN) for specified fire resistance time (fire resistance time in minutes)				Authority / No
		F30	F60	F90	F120	
HSL-3 	M8 M10 M12 M16 M20	3,0 7,0 10,0 19,4 30,0	1,1 2,0 3,5 6,6 10,3	0,6 1,3 2,0 3,5 5,4	0,4 0,8 1,2 2,2 3,5	IBMB Braunschweig UB 3041/1663-CM  Warrington
HSA, HSA-BW, HSA-R2, HSA-R 	M6 M8 M10 M12 M16 M20	0,20 0,37 0,87 1,69 3,14 4,90	0,18 0,33 0,75 1,26 2,36 3,68	0,14 0,26 0,58 1,10 2,04 3,19	0,10 0,18 0,46 0,84 1,57 2,45	IBMB Braunschweig 3215/229/12  Data valid for steel failure,
HUS-HR 	M6x30 M6x55 M8x60 M10x90 M14x90	0,5 1,3 1,5 4,0 6,3	0,5 1,3 1,5 4,0 6,3	0,5 1,3 1,5 4,0 6,3	0,4 1,0 1,2 2,4 5,0	Hilti Tech. data  DIBt Berlin / ETA-10/0005 acc. Part 6  DIBt Berlin ETA-08/0307
HUS3 	M8 M10 M14	3,2 6,1 10,4	2,4 4,6 7,8	0,5 3,1 5,3	0,4 2,4 4,0	DIBt Berlin / ETA-13/1038 Table C3  Data valid for steel failure, for other failure modes see ETA-13/1038
HKD 	M6x25 M8x25 M10x25 M12x25 M12x50 M16x65	0,5 0,6 0,6 0,6 2,3 4,0	0,4 0,6 0,6 0,6 2,3 4,0	0,3 0,6 0,6 0,6 2,3 4,0	0,2 0,5 0,5 0,5 1,8 3,2	DIBt Berlin ETA-06/0047 acc. Part 6  Warrington fire WF Report No 327804/A
HRD 8 / HRD 10 	only shear loads	1,9	1,4	1,0	0,7	MFPA Leipzig GS 3.2/10-157-1
DBZ 	M6/4,5 M6/35	0,6	0,5	0,3	0,2	DIBt Berlin; ETA-06/0179 acc. Part 6 Warrington fire WF Report No 327804/A
HVU + HAS 	M8 M10 M12 M16 M20	1,5 4,5 10,0 15,0 25,0	0,8 2,2 3,5 5,0 9,0	0,8 2,2 3,5 5,0 9,0	0,4 0,9 1,0 3,0 5,0	IBMB Braunschweig UB- 3333/0891-1  Warrington fire WF Report No 327804/B
HY 200 + HIT V (5.8) 	M8 M10 M12 M16 M20	1,20 2,00 3,00 6,20 9,70	0,45 0,75 1,80 2,55 7,80	0,24 0,40 0,89 1,29 5,85	0,17 0,28 0,59 0,86 3,61	IBMB Braunschweig 3501/676/12 Loads for typical embedment depth, cracked concrete. For variable embedment depth and non-cracked concrete see test report.  Warrington fire WF Report No 327804/B

**Project type Project name**

Project type	Project name
Commercial	<p>Bahrain Financial Harbour (Bahrain)</p> <p>Bahrain City Centre &amp; Kempinski Hotel (Bahrain)</p> <p>Bahrain Medical University (Bahrain)</p> <p>Arcapita Bank Headquarters (Bahrain)</p> <p>Office bldg for Ministry of Works and Housing (Bahrain)</p> <p>Hyper Panda Markets (KSA) Zuhair Fayiez</p> <p>Main Office (KSA) Al Turki Plaza Tower (KSA)</p> <p>Museum of Islamic Arts (Qatar) Dana Tower (Qatar)</p> <p>Convention Centre (Qatar) French School Damascus (Syria) Presidential Office Damascus (Syria) Salalah Mall (Oman)</p> <p>Royal Opera House (Oman) Maritime College Sohar (Oman) Philharmonic Complex Seeb (Oman) AUH (Lebanon)</p> <p>Old Sooks (Lebanon) Platinum (Lebanon) Metropolitan (Lebanon)</p> <p>Abdali Boulevard Amman (Jordan) Formula 1 Race Track in Yas Island (UAE) Masdar Institute Of Science &amp; Technology (UAE) Paris Sorbonne University (UAE)</p> <p>Mirdiff City Center (UAE) Dubai Metro (UAE) Festival Centre Dubai (UAE) Al Zeina Abu Dhabi (UAE)</p> <p>ADNEC Phase 2&amp;3 Abu Dhabi (UAE) Ferrari Theme Park (UAE)</p>
Residential	<p>Health Centre Sur (Oman) Atiyeh Hospital (Iran)</p> <p>Laleh Hospital (Iran) Grand Naft Hospital (Iran)</p> <p>American Hospital (UAE)</p> <p>Abraj Al Lulu (Bahrain) Villamar @ Harbour (Bahrain)</p> <p>Reef Island Development (Bahrain) King Palace in Sakhir (Bahrain)</p> <p>44 Storey Misnad Tower (Qatar) Canadian Embassy (Syria)</p> <p>Aldiar - Fishermen Houses (Syria) Wave Muscat (Oman)</p> <p>Palladium (Lebanon) Behshahr Tower (Iran)</p> <p>Nahid Tower (Iran)</p> <p>Index Tower Dubai (UAE)</p> <p>Al Jaber Tower Dubai (UAE)</p>
Power & Water	<p>IWPP at Al Dur (Bahrain) Desalination Water Plant (Bahrain) MW Qurayyah Power Plant (KSA)</p> <p>Al Jalamid Power plant &amp; Substations (KSA)</p> <p>Hawiyah Plant Expansion (KSA)</p> <p>Khurais Field Development Project (KSA)</p> <p>Marafiq Power &amp; Water (KSA)</p> <p>Shouaiba SPP (KSA) PP10 Power Plant (KSA)</p> <p>Qurayyah Power Plant &amp; WIP (KSA) Shoqa-iq WIPP Plant (KSA) Mesaieed Power Plant (Qatar)</p> <p>Dir Ali Power Plant (Syria) Rusayl Power Plant (Oman)</p> <p>450 kV Station Ksara (Lebanon) Damavand Gas Power plant (Iran)</p> <p>Masjed Soleyman Hydro Power Plant (Iran) Abbaspour Hydro Power Plant (Iran)</p> <p>Sanandaj Gas Power Plant (Iran)</p>
Airport	<p>N.D.I.A (Qatar)</p> <p>Mussannah Air Base (Oman)</p> <p>Imam Khomeini International Airport (Iran)</p> <p>Persian Gulf International Airport (Iran) Dubai International Airport (UAE)</p> <p>Dubai Airport Expansion (UAE)</p>
Bank	<p>CBQ Head office Tower (Qatar) Biblos Bank (Syria)</p> <p>NBD Muscat (Oman) Arab Bank HQ (Jordan)</p> <p>Abu Dhabi Financial Center (UAE)</p> <p>Hotel Marriot Executive Apartments (Bahrain)</p> <p>K-Hotel (Bahrain)</p> <p>Sofitel Hotel at Zallaq (Bahrain) La Cigale (Qatar)</p> <p>W- Hotel (Qatar)</p> <p>City Centre Phase -2 (Qatar)</p> <p>Four Seasons Hotel Damascus (Syria) Re-furbishment Of Muscat Sheraton (Oman)</p> <p>Rotana Park Hotel Abu Dhabi (UAE)</p> <p>Crown Plaza Abu Dhabi (UAE)</p> <p>Fairmont Palm Hotel &amp; Residences Dubai (UAE) Atlantis Resort &amp; Water Theme Park (UAE)</p> <p>Burj Dubai Lake Tower Hotel (UAE) Burj Khalifa (UAE)</p>
Industrial	<p>RUF Factory (Bahrain) GPIC (Bahrain) Gate Qatalum - Aluminium Smelter Plant (Qatar)</p> <p>Q-Chem 2 (Qatar)</p> <p>Naserieh &amp; Zaizoon P.P. Ext. (Syria) Al Jabber (Syria)</p> <p>Ramak Tour Damascus (Syria) Sarcheshmeh Cupper Complex (Iran) Khouzestan Steel Complex (Iran) Sepahan Cement Factory (Iran)</p> <p>Mirza Kouchak Suggar Industry (Iran)</p>
Oil & Gas	<p>KAYAN Offsites &amp; Utilities (KSA) Ammonia Plant at R Zour (KSA) DAP Plant at R Zour</p> <p>Yansab Offsites &amp; Utilities (KSA)</p> <p>Chevron NCP Project (KSA)</p> <p>North Jeddah Bulk Plant-ARAMCO (KSA)</p> <p>Petro Rabigh Plant (KSA)</p> <p>Gas Plant - Karchaganak (Kazakhstan) Duhail &amp; Muithar S/S - substations (Qatar) Gas to Liquid Plant - GTL (Qatar) Petrochemical LAB (Syria)</p> <p>South Gas Station Froklos (Syria) Borzouyeh Petrochemical Complex (Iran) Jam Petrochemical Complex (Iran) Doroud3 Petrochemical Complex (Iran) South Pars phase 9&amp;10 (Iran)</p>
Hospital nation	<p>King Hamad General Hospital (Bahrain) Inter- al Medical Center (KSA)</p> <p>King Faisal Hospital (KSA) King Fahad Hospital (KSA)</p> <p>King Fahad Specialist Hospital (KSA) Saudi German Hospital (KSA)</p> <p>King Faisal Speciality Hospital (KSA) DR. Ghassan Najieb Pharon (KSA) Health Centre Sohar (Oman) Psychiatric Hospital Hamrat (Oman)</p>

**Extracts from SANS 10400-T**
**4.6 Fire resistance of occupancy-separating and division-separating elements**

4.6.1 Any portion of a building that has an occupancy in any one of the groups of occupancies given in table 4 shall, subject to the requirements of 4.3, be separated by means of an occupancy- separating element from any portion of such building used for an occupancy in any other of such groups of occupancies.

Table 4 — Fire resistance of occupancy-separating elements

1	2	3	4	5	6	7	8	9	10	11	12	13	14	15	16	17	18
Occupancy groups	Fire resistance min																
	B1 D1	B2 D2	J1	A1 A2 A4 F1	F3	D4	E1 E2 E3 E4	A3	J2	F2	G1	J3	J4	H1 H2 H3 H4 H5	A5	C1 C2	B3 D3
B1, D1	•	120	120	120	120	120	120	120	120	120	120	120	120	120	120	120	120
B2, D2	120	•	120	120	120	120	120	120	120	120	120	120	120	120	120	120	120
J1	120	120	•	120	120	120	120	120	120	120	120	120	120	120	120	120	120
A1, A2, A4, F1	120	120	120	•	120	120	120	120	120	120	120	120	120	120	120	120	120
F3	120	120	120	120	•	120	120	120	120	120	120	120	120	120	120	120	120
D4	120	120	120	120	120	•	120	120	120	120	120	120	120	120	120	120	120
E1, E2, E3, E4	120	120	120	120	120	120	•	90	90	90	90	90	90	90	90	90	90
A3	120	120	120	120	120	120	90	•	90	90	60	60	60	60	60	60	60
J2	120	120	120	120	120	120	90	90	•	90	60	60	60	60	60	60	60
F2	120	120	120	120	120	120	90	90	90	•	60	60	60	60	60	60	60
G1	120	120	120	120	120	120	90	60	60	•	60	60	60	60	60	60	60
J3	120	120	120	120	120	120	90	60	60	60	•	60	60	60	60	60	60
J4	120	120	120	120	120	120	90	60	60	60	60	•	60	60	60	60	60
H1, H2, H3, H4, H5	120	120	120	120	120	120	90	60	60	60	60	60	•	60	60	60	60
A5	120	120	120	120	120	120	90	60	60	60	60	60	60	•	60	60	60
C1, C2	120	120	120	120	120	120	90	60	60	60	60	60	60	60	•	60	60
B3, D3	120	120	120	120	120	120	90	60	60	60	60	60	60	60	60	•	60

4.6.2 Where any occupancy-separating element is required, in terms of 4.6.1, such occupancy- separating element shall have a fire resistance of not less than that given in table 4. Where, in terms of 4.4, a division-separating element is required, such division-separating element shall have a fire resistance of not less than that given in table 5.

Table 5 — Fire resistance of division-separating elements

1	2
Occupancy	Fire resistance min
All occupancies other than those mentioned below	60
B1, C1, D1, E1, E2, E3, F1, F3, J1	120

4.6.3 Any movement joint in a division-separating or occupancy-separating element shall have the same fire resistance rating as that required for the separating element.

4.6.4 No combustible roof components shall penetrate the occupancy-separating elements or division-separating elements between occupancies and divisions.

**4.32 Provision and maintenance of fire-fighting equipment, installations and fire protection systems**

4.32.1 Any fire-fighting equipment, installations and fire protection systems in any building shall be so installed and maintained as to be ready for their purpose at all times.

**4.40 Protection in service shafts**

4.40.1 The walls of an internal service shaft shall have a fire resistance of not less than the requirements for structural stability given in table 6, subject to a maximum requirement of 120 min.

4.40.2 Where a vertical service shaft provided in a building is not separated from the floors it serves by a separating element, and such shaft does not contain any combustible material, it shall be fire-stopped at the level of every second storey above the bottom of such shaft. Such fire stop shall have a fire resistance of not less than the requirements for structural stability given in table 6, subject to a maximum requirement of 120 min.

4.40.3 Where such a shaft is so provided and it contains any combustible material, it shall be fire- stopped at the level of every storey above the bottom of such shaft.

4.40.4 Where a vertical service shaft is used for ventilation or contains non-combustible plumbing or drainage services or is a non-combustible rubbish chute, no fire stop shall be required within such shaft, and the doors to such shafts shall be self-closing fire doors in accordance with the requirements of 4.10.

4.40.5 Where a service penetrates a separating element, such separating element shall be fire- stopped with a suitable system of the same rating of the element it passes through. Such system shall have a test report prepared in accordance with the requirements of SANS 10177-2 and shall be installed in accordance with the provisions relating thereto.

**Regulations**
**T1 General Requirement**

(1) Any building shall be so designed, constructed and equipped that in case of fire –

(a) the protection of occupants or users, including persons with disabilities, therein is ensured and that provision is made for the safe evacuation of such occupants or users;

(b) the spread and intensity of such fire within such building and the spread of fire to any other building will be minimized;

(c) sufficient stability will be retained to ensure that such building will not endanger any other building: Provided that in the case of any multi-storey building no major failure of the structural system shall occur;

(d) the generation and spread of smoke will be minimized or controlled to the greatest extent reasonably practicable; and

(e) adequate means of access, and equipment for detecting, fighting, controlling and extinguishing such fire, is provided.

(2) The requirements of subregulation (1) shall be deemed to be satisfied where the design, construction and equipment of any building complies with SANS 10400-T: Provided that where any local authority is of the opinion that such compliance would not comply with all the requirements of subregulation (1), such local authority shall, in writing, notify the owner of the building of its reasons for its opinion and may require the owner to submit for approval a rational design prepared by an approved competent person.

**T2 Offences**

(1) Any owner of any building who fails to –

(a) provide sufficient fire extinguishers to satisfy the requirements of subregulation T1(1)(e), or who installs fire extinguishers that do not comply with the relevant South African national standard, or who fails to ensure that such fire extinguishers are installed, maintained and serviced in accordance with SANS 10105; or

(b) maintain any other provision made to satisfy the requirements of subregulation T1(1)(e), shall be guilty of an offence.

## Extracts from ASIB

To assist in what is required for Passive Fire Protection the Association for Specialist Fire Protection (ASFP) has set up guidelines for the Inspection of Passive Fire Protection for Fire Risk Assessors. Extracts from this guide can be found below which would be relevant to the SA market as well.

### 5. Penetrating service in walls, ceiling and floors forming escape routes

#### 5.1 General

If a fire separating element is to be effective, every joint or imperfection of fit, or opening to allow services to pass through the element, needs to be adequately protected by sealing or fire stopping so that the fire resistance of the element is not impaired. The provision of fire resisting walls, ceilings and floors forming escape routes is most commonly compromised by the installation of penetrating services (pipes, cables, air handling equipment etc.) through the wall or floor. In new buildings, the building Regulations address this by requiring the inclusion of suitable fire-stopping. However, this is often compromised by:

- Use of poor quality products. The ASFP recommend the use of third party certified products
- Poor quality/ lack of installation. The ASFP recommend the use of third party certificated contractors
- Addition, removal or modification of penetrating services after the building is completed without correct reinstatement of the fire-stopping,

Because this usually occurs after the building control and handover process is complete, it is often not picked up because it is out of sight. Only a regular inspection and maintenance regime will identify this. In some cases, it will be the fire risk assessor who will be the first person to discover and record this.

#### 5.2.1 Cables and pipes

The assessor will need to ensure that any services penetrating walls or floors abutting escape routes are adequately sealed where they penetrate the wall or floor. He should pay particular attention to penetration services above suspended ceilings where they might have been installed and not made good afterwards. The presence of any through holes or gaps is not acceptable and these must be made good with appropriate tested/ certificated construction that is compatible with the existing penetration seal.

There are a variety of proprietary materials and products used to seal penetrations including intumescent collars and wraps, fire-resisting mortars, coated mineral fibre bats, fire-resisting pillows, etc. The fire risk assessor is not expected to be an expert in all of these, but he should be aware of the limitations of the generic material types. The assessor should be particularly vigilant if he discovers the use of expanded foam as a penetration sealing material. Most of these are tested as narrow linear gap seals and will not work in a large penetration seal. Further guidance is given in Annex G including guidance on PU foams.

#### 5.2.2 Ducts and Dampers

Where air handling ducts pass through fire separating elements the integrity of those elements is maintained by using one of three basic methods:

- Method 1: Protection using fire dampers
- Method 2: Protection using fire resistant enclosures
- Method 3: protection using fire-resisting ductwork

The assessor must understand which method has been used to undertake his risk assessment. Where air handling systems pass through fire-resisting construction on escape routes or compartments walls and floors forming escape routes, particular attention needs to be placed on the following:

#### Method 1: Protection using fire dampers

A fire damper is a device which is installed at the point where the duct penetrated the compartment wall or floor. Fire dampers should be situated within the thickness of the fire separating element and be securely fixed. The fire damper allows the ventilated air in normal conditions to pass through a duct, wall or partition. In a fire situation it closes automatically to prevent the passage of fire for a stipulated time period.

#### 5.2.3 Support for penetrating services

Penetrating services will need to be supported either side of the wall or floor to ensure that in a fire any drooping or sagging of the service does not damage the penetration seal and thus breach fire-resisting construction. Some types of penetration seal e.g. mineral fibre batt are more susceptible to damage by collapse of the service than others e.g. fire-resisting mortars.

### 6.3 External fire spread

If the building has a discrete external façade, this can provide the potential for significant spread of fire up the face of the building. Several fires resulting in fatalities have been exacerbated by fire spread up the outside of the building, but inside the rain screen cladding. These fires can then re-enter the building e.g. via windows. Consequently, when assessing buildings with any applied rain screen or external cladding e.g. high rise offices or blocks of flats, particular attention should be given to any rain screen or other external cladding system that has been applied to any facade that have been replaced.

It is unlikely that the fire risk assessor will be able to inspect this himself. Consequently, he should look at the recorded of the installation of the system provided by the installer. If he is in any doubt, he may require the assistance of a specialist third party inspection organisation to determine whether there is adequate provision of rain screen cavity barriers.

#### Annex G: Fire-stopping and penetration seals

Mechanical and electrical services, by necessity, breach fire-resisting construction on escape routes and compartment walls and floors will allow the passage of smoke and flame if not adequately fire-stopped. There is a wide range of products that are designed for use as fire-stopping and penetration seals. These include products based upon mineral wool; high and low pressure intumescent, mortars, pillows filled with fire-resisting materials, plugs and blocks, elastomers, putties, foams and mastics.

Evaluation of the fire resistance of fire-stopping and penetration seals has traditionally been undertaken by using ad-hoc procedures based on BS 476: Part22:1987 as there was no dedicated British Standard for these. Increasingly, manufacturers are using the European standard EN 1366-3 for penetration seals and EN 1366-4 for linear gap seals. The European standards are more rigorous and contain a wealth of guidance on how to test these products.

The crucial issues for fire-stopping are poor installation and/ or the breaching of fire-resisting construction on escape routes and fire compartmentation after installation and handover. Unlike e.g. a fire door where any defective remedial work will normally be readily apparent and easily inspected, defects in fire-stopping and penetration sealing often remain out of sight and consequently out of mind. The fire risk assessor in checking for the presence and condition of penetration seals in walls forming escape routes will be able to at least perform a "first aid" check on service penetrations. However, to evaluate the condition of fire-stopping, inspection other than in areas that are readily accessible, is unlikely to be an option and/ or too invasive.

The best solution for ensuring that fire-stopping is installed properly is to use third party certified contractors. These are required to use trained staff, whose competence has been evaluated and whose records are subject to audit by the certification body and whose work is subject to random inspection by qualified inspectors. However, if in the course of his "first-aid" inspection of fire-stopping, the assessor discovers significant failings, he should ask for an appropriate survey from an independent third party inspection organisation.

**Toll Free: 08000 23331**